



***Product guide***

2024/25



*For the defining details*





Our Grove collection photographed in our satin antique satin lacquered (SAS) finish.





# Product guide

## Introduction

Our story	6	Queslett	38-39
Atelier by Armac Martin	9	Withenshaw	40
Our finishes	10	Washwood	41
Signature finishes	14		
Speciality finishes	15		
Luxe finishes	16		

## Collections

### Signature collection

Quinton	20	<b>Speciality collection</b>	
Jaspette	21	Bromford	44
Croxford	22	Kingsheath	45
Bromsgrove	23	Sparkbrook	46
Arbar	24-25	Leebank	48
Longbridge	26	Carlton	49
Edgbaston	27	Lincoln	50
Crossways	28-29	Rotunda	51
Aberdovey	30	Jefferson	52
Bournville	31	Gaumont	53
Cotswold	32-33	Sutton	54
Bakes	36-37	Belgrave	55
		Snowdrift	56
		Merrick	57
		Latchford	58-59
		Colmore	60-61

### Luxe collection

Barwick Ridged	64-66
Barwick Plain	67-69



Digbeth Ridged	70-71
Digbeth Plain	72-73
MIX Diamond	74-75
MIX Straight	76-77
MIX Plain	78-79
Bromwich	80
Victoria Stepped	82-84
Victoria Plain	85-87
Oblique	88
Quadrille	89
Dougan	90
Grove	92-93
Harold	94-95
Flush Pulls	96-97

### **Decorative grilles**

Grille finishes	100-101
Regency Diamond	102-103
Elliptical	104-105
Georgian Square	106-107
Diamond Interwoven	108-109
Square Interwoven	110-111

Double Square Interwoven	112-113
Double Diamond Interwoven	114-115
Double Rectangular Interwoven	116-117
Perforated sheets	118-119
Grille frames	120
Mesh	121
Ordering your grille	122

### **Accessories**

Claremont mirrors	126-127
Cotswold brass rails	128-129
Brindley hanging wine glass rack	131
Shelf brackets	132-133
Wall hooks	134-137
Cabinet hinges	138
Card frames	139
Magnetic catches	140
Finials & screws	141

<b>Contact us</b>	143
-------------------	-----

<b>Acknowledgments</b>	144
------------------------	-----



## *Our story*

95 years in the making

Since 1929, Armac Martin has been dedicated to creating design-led luxury brass hardware and accessories in the heart of England.

With humble beginnings as the business of local brass founder Harold McGrail who manufactured reproduction furniture fittings, Armac Martin is now an award-winning, fourth-generation family business and a leading name in the luxury interiors industry.

We believe in exceptional design and exquisite detail; in celebrating true craftsmanship and in the art of using the finest materials to form made-to-last brass hardware, shelf brackets, mirrors and more.

Our reputation is built on our heritage and our innovative brass products are favoured by architects, designers, property developers and customers the world over.

In the spring of 2022, we were honoured with a Queen's Award for Enterprise for International Trade, an incredible accolade for our whole team that nationally recognises our growth and commercial success.









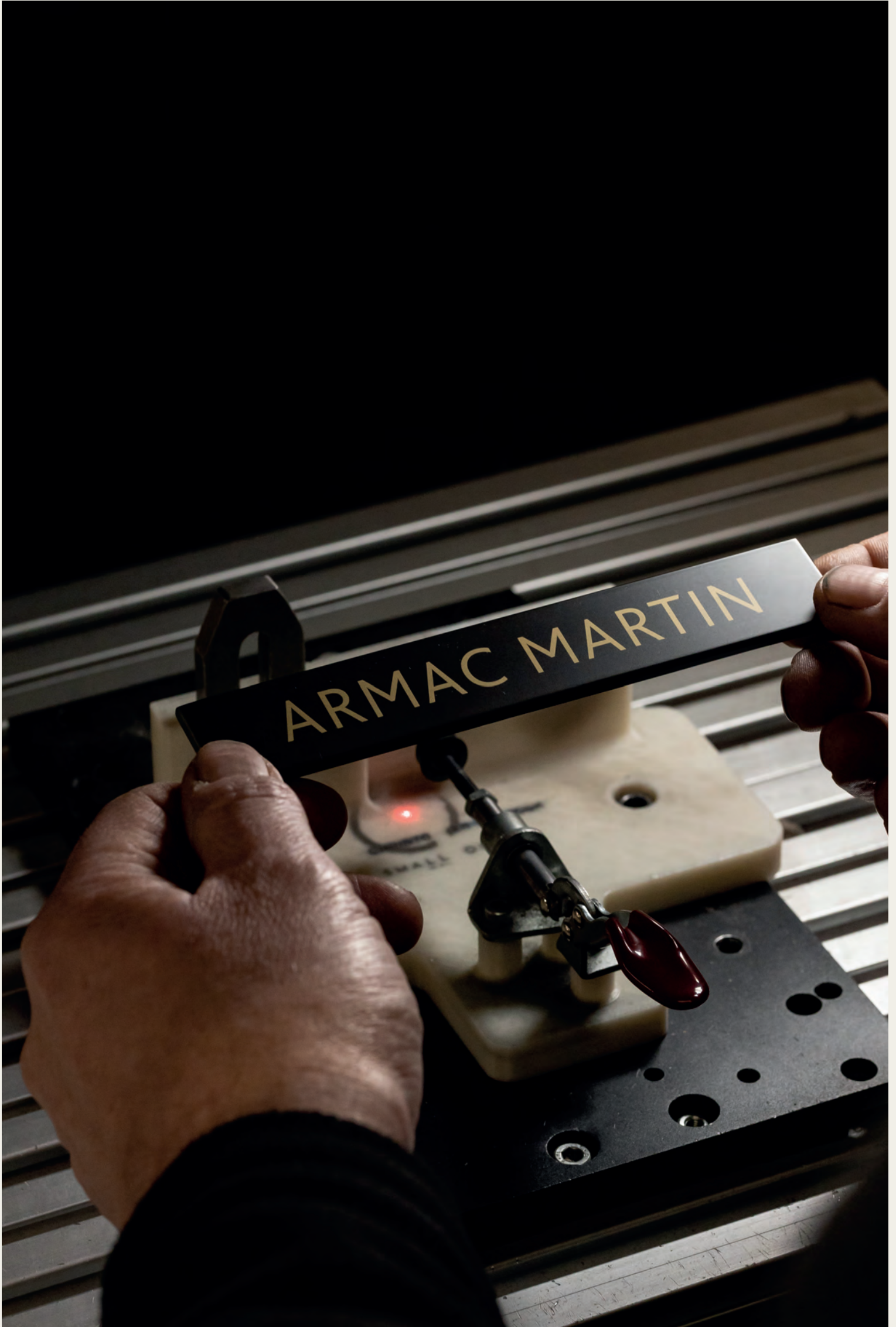





# *Atelier by Armac Martin*

## **Our bespoke service**

For bespoke brass products, Atelier by Armac Martin is at your service.

We understand that sometimes, your project may require a unique brass piece, or indeed, a collection and we're delighted to provide both full and partial bespoke design and manufacturing services for our luxury brass products.

With nearing a century of experience, let our highly skilled team impeccably transform your ideas into bespoke brass pieces.

We invite each of our Atelier clients to experience Armac Martin in person with a visit to our Birmingham factory, where our design experts can help to inspire your designs and you can discover the manufacturing process up close.

### **Our bespoke service includes:**

CAD – 3D rendering and technical drawings so you can clearly visualise your hardware.

3D printing from our prompt prototyping machine to produce a resin prototype that you can see and feel to experience the design and proportions.

Laser engraving to subtly add your own branding on a wide array of bespoke products and our core collections.

Expert technical sales support so you have personal guidance throughout.

### **Fully bespoke**

No matter what form your design ideas are in, work with our dedicated team to create a completely bespoke product. From size and style to branded engraving, we'll create 3D designs so you can experience how the finished hardware will look and feel to ensure it fits with your project, before creating final technical drawings for you to sign off before production begins.

Lead times are primarily between 8 - 12 weeks for this service.

### **Partially bespoke**

Our partially bespoke service is perfect for when you've found the hardware pieces within one of our core collections, yet the measurements aren't quite right for your design. We can customise the length, diameter and projection for you so that the hardware fits perfectly for your project.

Lead times are primarily between 6 - 8 weeks for this service.



## *Our finishes*

The final flourish

We truly believe that luxury is in the detail and so we take great pride in offering our customers a curated choice of beautiful finishes to ensure your hardware has the look and feel you desire.

Each of our luxury cabinet hardware products and accessories are made from the finest solid brass and we apply an array of plated and patinated finishes to create an exquisite look for each - many of which are hand-finished by our team of expert polishers in the heart of Birmingham.







**BEL - Aged brass**



**AGC - Aged copper**



**NBP - Aged nickel**



**DAB - Dark aged brass**



**SBUL - Satin brass  
unlacquered**



**PBUL - Polished brass  
unlacquered**



**PBL - Polished brass  
lacquered**



**SBL - Satin brass  
lacquered**



**SBSL - Satin brass satin  
lacquered**



**PNP - Polished nickel plate**



**PCP - Polished chrome plate**



**SNP - Satin nickel plate**



**SCP - Satin chrome plate**



**HBN - Hand burnished nickel**



**HBB - Hand burnished brass**



**FEA - Fine English antique**



**SAS - Satin antique satin  
lacquered**



**DBZ - Dark bronze**



**MBL - Matt black lacquered**

**Hand-finished by**  
our team of expert  
polishers in the heart  
of Birmingham.



## Signature *finishes*

This category features our introductory price point of best-selling finishes. Choose from a selection of beautiful hand finishes that are achieved with a select number of processes.



### **BEL - Aged brass**

The product is hand sateened to give a brushed satin finish, a light antique patina is then applied to the brass before being placed into barrelling machines. As it is a living finish, this naturally aged appearance will further age and darken slightly over time.



### **AGC - Aged copper**

The product is hand sateened to give a brushed satin finish and is then plated with copper. It is next dipped into an antiquing solution before being placed in barrelling machines to produce the aged appearance. As it is a living finish, this naturally aged appearance will further age and darken slightly over time.



### **NBP - Aged nickel**

The product is hand sateened to give a brushed satin finish. The product is then lightly distressed. Finally, a dull nickel plate is applied to the product. This is a living finish which will oxidise over time.



### **DAB - Dark aged brass**

The product is hand sateened to give a brushed satin finish then a dark antique patina is applied to the brass before being placed into barrelling machines to produce the aged appearance. As it is a living finish, this naturally aged appearance will further age and darken slightly over time.



### **SBUL - Satin brass unlacquered**

The product is hand sateened to give a brushed satin finish. As this is a living finish, the finish will naturally oxidise and patina over time.



### **PBUL - Polished brass unlacquered**

The product is hand sateened to give a brushed satin finish, a light antique patina is then applied to the brass before being placed into barrelling machines. As it is a living finish, this naturally aged appearance will further age and darken slightly over time.

## Speciality *finishes*

This category features our mid-tier priced finishes. Choose from a range of beautiful hand finishes that are coated by our expert lacquerers and platers using highly skilled techniques.



### **PBL - Polished brass lacquered**

Hand-polished to a smooth mirrored finish, a highly durable clear gloss lacquer is applied and baked in our ovens to ensure the lacquer cures to offer lasting protection.



### **SBL - Satin brass lacquered**

The product is hand sateened to give a brushed satin finish. A highly durable clear gloss lacquer is then applied which is baked in our ovens to ensure the lacquer cures to offer lasting protection. Gloss finish.



### **SBSL - Satin brass satin lacquered**

The product is hand sateened to give a brushed satin finish. A highly durable clear satin lacquer is then applied and baked in our ovens to ensure the lacquer cures to offer lasting protection. Matt finish.



### **PNP - Polished nickel plate**

The product is hand polished to a smooth mirrored finish. A bright nickel plate is then applied. The nickel plate provides a durable finish and has a warmer tone than chrome.



### **PCP - Polished chrome plate**

The product is hand polished to a smooth mirrored finish. A bright nickel plate is then applied before a chromium plate is applied on top of the nickel. Chromium plate provides a durable and hard-wearing finish.



### **SNP - Satin nickel plate**

The product is hand sateened to give a brushed satin finish. A dull nickel plate is then applied. The nickel plate provides a durable finish and has a warmer tone than chrome.

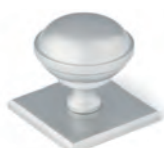

### **SCP - Satin chrome plate**

The product is hand sateened to give a brushed satin finish. A dull nickel plate is then applied before a chromium plate is applied on top of the nickel. Chromium plate provides a durable and hard-wearing finish.





## Luxe *finishes*

This category features our most exquisite finishes, each requiring additional specialist hand-finishing processes to achieve the desired appearance.



### **HBN - Hand burnished nickel**

The product is hand polished to a smooth mirrored finish. A bright nickel plate is then applied. The finisher then hand burnishes the product to achieve a natural-looking aged appearance, the hand-burnished nickel finish is classed as a living finish which will oxidise over time.



### **HBB - Hand burnished brass**

The product is hand polished to a smooth mirrored finish. The finisher then hand burnishes the product to achieve a natural-looking aged appearance. The hand-burnished brass finish is not lacquered and as a result, is classed as a living finish which will oxidise over time.



### **FEA - Fine English antique**

The product is hand sateened to give a brushed satin finish. It is then dipped in an antique solution before being relieved by hand. This is a living finish.



### **SAS - Satin antique satin lacquered**

The product is hand sateened to give a brushed satin finish. An antique patina is then applied to the brass and relieved to give the satin antique finish. Finally, a highly durable clear satin lacquer is then applied and baked in our ovens to ensure the lacquer cures to offer lasting protection.



### **DBZ - Dark bronze**

The product is hand sateened to give a brushed satin finish. A bronzing powder is evenly applied by hand to give a smooth consistent finish before being relieved on the polishing lathe. This is a living finish.



### **MBL - Matt black lacquered**

The product is hand sateened and shot blasted to give the metal the desired surface finish. A highly durable matt black-coloured lacquer is then applied which is baked in our ovens to ensure the lacquer cures to offer lasting protection.



Our Grove collection photographed in our satin antique satin lacquered (SAS) finish.







# Quinton collection

Contemporary

Inspired by Mondrian's iconic Cubism era, Quinton is a modern collection of extruded cabinet pulls.



## Quinton Cabinet Pull

Code	Height (H)	Length (L)	Centres (C)	Projection (P)
QNT/50	16mm	50mm	32mm	25mm
QNT/120	16mm	120mm	96mm	25mm
QNT/150	16mm	150mm	128mm	25mm
QNT/312	16mm	312mm	288mm	25mm
QNT/400	16mm	400mm	368mm (+centre hole)	25mm
QNT/500	16mm	500mm	464mm (+centre hole)	25mm

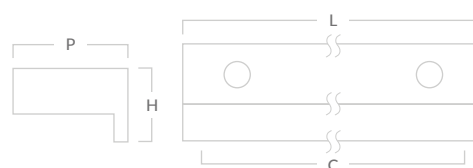

In-situ photographed in our matt black lacquered (MBL) finish. Product photographed in our dark bronze (DBZ) finish.

# Jaspette collection

Contemporary

Minimalist curved linear shapes effortlessly form the design of the Jaspette collection.



## Jaspette Cabinet Pull

Code	Length (L)	Centres (C)	Height (H)	Projection (P)
JPT/50	50mm	32mm	19mm	22mm
JPT/110	110mm	96mm	19mm	22mm
JPT/180	180mm	160mm	19mm	22mm
JPT/310	310mm	290mm (+centre hole)	19mm	22mm
JPT/400	400mm	368mm (+centre hole)	19mm	22mm
JPT/500	500mm	448mm (+centre hole)	19mm	22mm



All products photographed in our aged brass (BEL) finish.



# Croxford collection

Contemporary

Featuring angled edges and clean lines, the Croxford collection is a fresh choice. Linear in design and extruded to create a functional cabinet pull.



## Croxford Cabinet Pull

Code	Length (L)	Centres (C)	Width (W)	Projection (P)
CRX/50	50mm	32mm	20mm	21mm
CRX/114	114mm	96mm	20mm	21mm
CRX/150	150mm	128mm	20mm	21mm
CRX/312	312mm	288mm	20mm	21mm
CRX/400	400mm	368mm (+centre hole)	20mm	21mm
CRX/500	500mm	464mm (+centre hole)	20mm	21mm



All products photographed in our aged brass (BEL) finish.

# Bromsgrove collection

Contemporary

For minimal design with maximum impact, choose the 'modern simplicity' of the Bromsgrove collection.



## Bromsgrove Cabinet Knob

Code	Width (W)	Projection (P)	Base (B)
BRGK/32	32mm	30mm	13mm

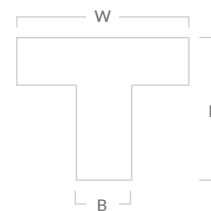

## Bromsgrove Cabinet Handle

Code	Length (L)	Centres (C)	Projection (P)	Square Bar
BRG/45	45mm	35.5mm	31mm	9.5mm
BRG/96	106mm	96mm	31mm	9.5mm
BRG/128	138mm	128mm	31mm	9.5mm
BRG/203	213mm	203mm	32mm	9.5mm
BRG/305	318mm	305mm	32mm	12.7mm



## Bromsgrove Appliance Handle

Code	Length (L)	Centres (C)	Projection (P)	Square Bar
BRG/APP/381	397mm	381mm	46mm	16mm
BRG/APP/608	624mm	608mm	46mm	16mm



In-situ photographed in our satin antique satin lacquered (SAS) finish. Product photographed in our satin brass satin lacquered (SBSL) finish.

# Arbar collection

Contemporary

The Arbar collection features cylindrical handles for a timeless, less is more look.



## Arbar Cabinet Knob

Code	Diameter (Dia.)	Projection (P)	Base (B)
ARBK/32	32mm	27mm	16mm
ARBK/38	38mm	31mm	17mm

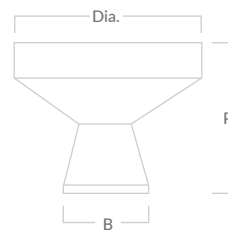

## Arbar T-bar Handle

Code	Width (W)	Projection (P)	Bar Diameter
ARBT/51	51mm	37mm	12.7mm

Not suitable for appliance doors

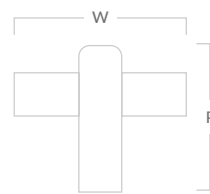

## Arbar Cabinet & Appliance Handle

Code	Length (L)	Centres (C)	Projection (P)	Bar Diameter
ARB/73	102mm	73mm	37mm	12.7mm
ARB/124	152mm	124mm	37mm	12.7mm
ARB/175	203mm	175mm	37mm	12.7mm
ARB/226	254mm	226mm	37mm	12.7mm
ARB/APP/368	416mm	368mm	56mm	19mm
ARB/APP/608	656mm	608mm	56mm	19mm

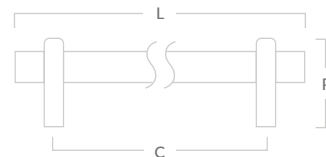





All products photographed in our aged brass (BEL) finish.

# Longbridge collection

Contemporary

Clean lines lead the design of a range of extruded pull handles in the Longbridge collection.



## Longbridge Cabinet Pull

Code	Length (L)	Centres (C)	Height (H)	Projection (P)
LON/32	32mm	N/A	28mm	26mm
LON/76	76mm	64mm	28mm	26mm
LON/180	180mm	160mm	28mm	26mm
LON/312	312mm	288mm	28mm	26mm

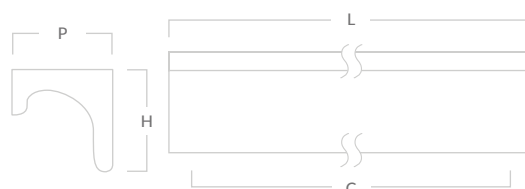

All products photographed in our aged brass (BEL) finish.



# Edgbaston collection

Contemporary

Go back to basics with the Edgbaston collection, a range of simplistic linear pull handles.



## Edgbaston Cabinet Pull

Code	Length (L)	Centres (C)	Height (H)	Projection (P)
EDG/50	50mm	32mm	25mm	48mm
EDG/110	110mm	96mm	25mm	48mm
EDG/180	180mm	160mm	25mm	48mm
EDG/312	312mm	288mm	25mm	48mm
EDG/400	400mm	368mm (+centre hole)	25mm	48mm
EDG/500	500mm	464mm (+centre hole)	25mm	48mm

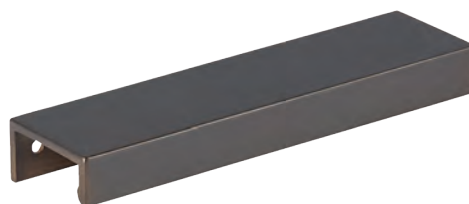
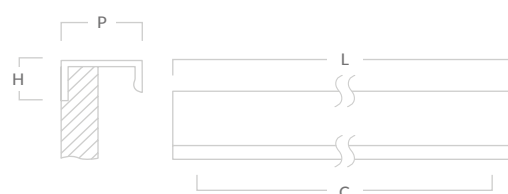

In-situ photographed in our satin antique satin lacquered (SAS) finish. Product photographed in our dark bronze (DBZ) finish.



# Crossways collection

Classic

Featuring stylish geometric shapes, the Crossways collection has distinct Art Deco appeal.



## Crossways Cabinet Knob

Code	Projection (P)	Base (B)	Across flats (AF)
CRWK/32	28mm	13mm	32mm

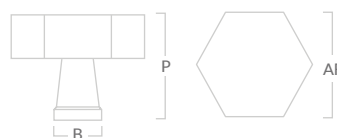

## Crossways T-bar Handle

Code	Width (W)	Projection (P)	Base (B)	Across flats (AF)
CRWT/55	55mm	33mm	13mm	12mm

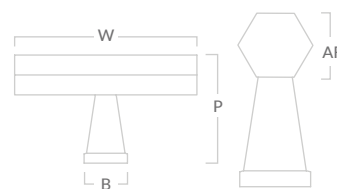

All products photographed in our satin antique satin lacquered (SAS) finish.

### Crossways Cabinet Ring Pull

Code	Width (W)	Height (H)	Rose (R)
CRWR/36	36mm	46mm	25mm

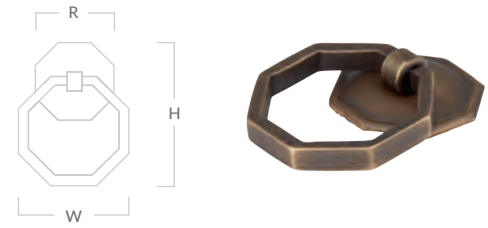

### Crossways Cup Pull

Code	Centres (C)	Width (W)	Height (H)
CRW/CUP/104	90mm	104mm	45mm

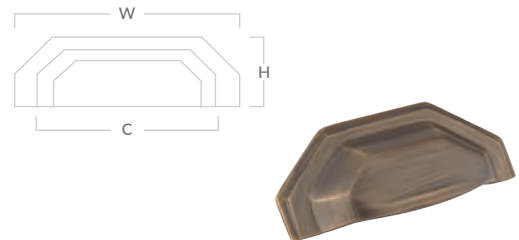

### Crossways Cabinet Handle

Code	Centres (C)	Length (L)	Projection (P)
CRW/64	64mm	102mm	33mm
CRW/96	96mm	134mm	33mm
CRW/128	128mm	166mm	33mm
CRW/160	160mm	198mm	33mm
CRW/288	288mm	326mm	33mm

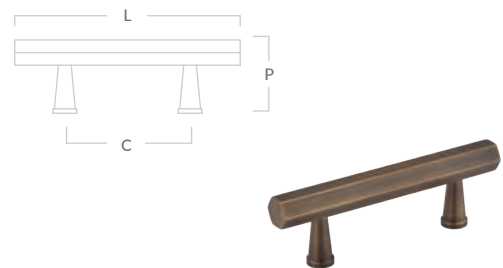

### Crossways Appliance Handle

Code	Centres (C)	Length (L)	Projection (P)
CRW/APP/384	384mm	434mm	45mm
CRW/APP/608	608mm	658mm	45mm

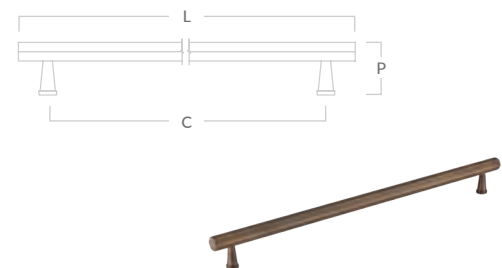

### Crossways Cabinet Drop Handle

Code	Centres (C)	Width (W)	Height (H)
CRWC/80	80mm	105mm	38mm
CRWC/102	102mm	129mm	47mm



### Crossways Hex Drop Handle

Code	Width (W)	Projection (P)	Height (H)
CRWD/80	25mm	16mm	56mm



# Aberdovey collection

Classic

Showcasing elegant shell-style curves, the Aberdovey collection embraces tradition with a coastal feel.



## Aberdovey Cabinet Knob

Code	Width (W)	Projection (P)	Base (B)
ABDK/32	32mm	27mm	15mm
ABDK/38	38mm	35mm	15mm

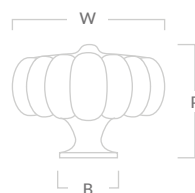

## Aberdovey Drawer Pull

Code	Width (W)	Height (H)
ABD/PULL/FF	102mm	48mm

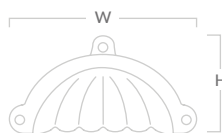

## Aberdovey Shell Cup Pull

Code	Width (W)	Height (H)
ABD/PULL/RF	92mm	36mm

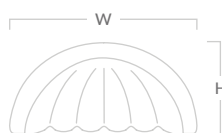

All products photographed in our aged brass (BEL) finish.



# Bournville collection

Classic

Embrace tradition with the sleek curves of the Bournville collection.



## Bournville Cabinet Knob

Code	Width (W)	Projection (P)	Base (B)
BNVK/35	35mm	22mm	22mm
BNVK/51	51mm	32mm	32mm

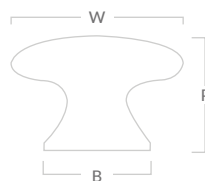

## Bournville Cabinet Handle

Code	Length (L)	Centres (C)	Projection (P)
BNV/86	100mm	86mm	30mm
BNV/160	178mm	160mm	38mm
BNV/254	279mm	254mm	50mm

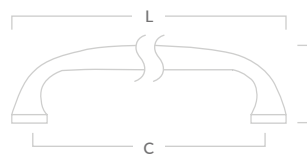

## Bournville Appliance Handle

Code	Length (L)	Centres (C)	Projection (P)
BNV/APP/330	360mm	330mm	61mm

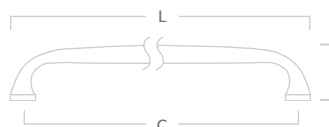

In-situ photographed in our satin antique satin lacquered (SAS) finish. Product photographed in our aged brass (BEL) finish.

# Cotswold collection

Classic

Inspired by the the iconic English countryside, the Cotswold collection draws on the aesthetic of traditional country homes.



## Cotswold Ball Knob

Code	Diameter (D)	Projection (P)	Base (B)
COTK/BALL/19	19mm	30mm	19mm
COTK/BALL/25	25mm	37mm	25mm
COTK/BALL/32	32mm	44mm	32mm
COTK/BALL/38	38mm	55mm	38mm



## Cotswold Mushroom Knob

Code	Diameter (D)	Projection (P)	Base (B)
COTK/MUSH/19	19mm	25mm	19mm
COTK/MUSH/25	25mm	29mm	25mm
COTK/MUSH/32	32mm	33mm	32mm
COTK/MUSH/38	38mm	38mm	38mm



In-situ photographed in our satin antique satin lacquered (SAS) finish. Product photographed in our aged brass (BEL) finish.

## Cotswold Bun Knob

Code	Diameter (D)	Projection (P)	Base (B)
COTK/BUN/19	19mm	19mm	21mm
COTK/BUN/25	25mm	26mm	27mm
COTK/BUN/32	32mm	33mm	32mm
COTK/BUN/38	38mm	37mm	38mm



## Cotswold Cup Pull

Code	Width (W)	Centres (C)	Height (H)
COT/PULL/56/RF	56mm	38mm	32mm
COT/PULL/92/RF	92mm	76mm	41mm

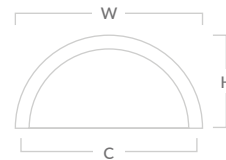

## Cotswold Drawer Pull

Code	Width (W)	Height (H)
COT/PULL/FF	98mm	49mm



## Cotswold Cabinet Handle

Code	Width (W)	Height (H)	Centres (C)
COT/CAB/76	107mm	53mm	76mm
COT/CAB/89	125mm	58mm	89mm
COT/CAB/102	140mm	63mm	102mm

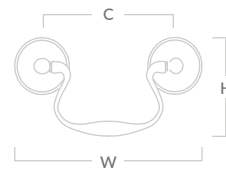

## Cotswold Cupboard Turn

Code	Height (H)	Width (W)	Projection (P)
COT/TURN/38	54mm	38mm	34mm

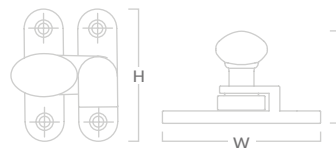

## Cotswold Cupboard Latch

Code	Height (H)	Width (W)	Projection (P)
COT/LATCH	55mm	50mm	32mm

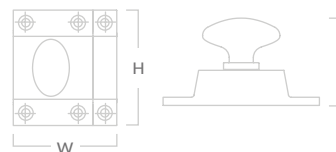





Our Washwood and Cotswold collections photographed in our polished brass lacquered (PBL) finish.







# Bakes collection

Classic

Designed by leading kitchen designer Robert Bakes, the Bakes collection presents fluid edges to bring an effortless look and feel to your cabinetry.



## Bakes Cabinet Knob

Code	Depth (D)	Width (W)	Projection (P)
BBFK01	38mm	51mm	35mm
BBFK02	32mm	45mm	30mm
BBFK03	23mm	32mm	22mm

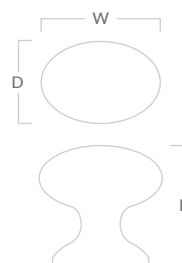

## Bakes Cabinet & Appliance Handle

Code	Length (L)	Centres (C)	Projection (P)	Bar width
BBF01	375mm	320mm	51mm	28x13mm
BBF02	244mm	203mm	38mm	18x13mm
BBF03	182mm	152mm	31mm	14x10mm
BBF04	153mm	127mm	26mm	12x9mm
BBF05	126mm	102mm	26mm	10x8mm

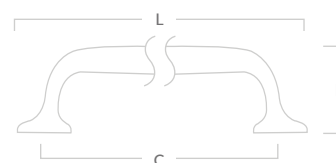

All products photographed in our aged brass (BEL) finish.





### Bakes Flush Latch

Code	Latch (L)	Width (W)	Projection (P)
BBF/LATCH/FLUSH	150mm	58mm	47mm
BBF/LATCH/OFFSET	150mm	58mm	47mm

Offset latch has 9.5mm offset

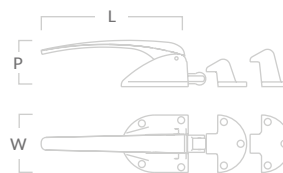

### Bakes Hinge

Code	Width (W)	Length (L)	Projection (P)
BBF/HINGE	76mm	120mm	21mm

Offset hinge has 9.5mm offset

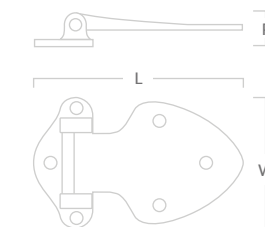

All products photographed in our aged brass (BEL) finish.

# Queslett collection

Classic

Presenting a beautiful blend of form and function, the Queslett collection has a classic New England look.



## Queslett Cabinet Knob

Code	Diameter (D)	Projection (P)	Base (B)
QK/KNOBONLY/28	28mm	26mm	12mm
QK/KNOBONLY/34	34mm	32mm	12mm
QK/KNOBONLY/40	40mm	35mm	16mm
QK/KNOBONLY/45	45mm	36mm	17mm

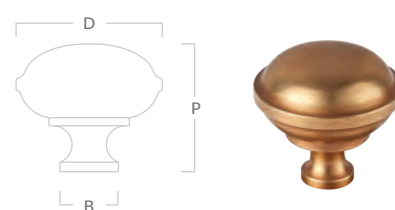

## Queslett Cabinet Knob with Square Backplate

Code	Diameter (D)	Base plate (B)	Projection (P)
QK/28	28mm	32x32mm	30mm
QK/34	34mm	38x38mm	36mm
QK/40	40mm	44x44mm	39mm
QK/45	45mm	51x51mm	40mm

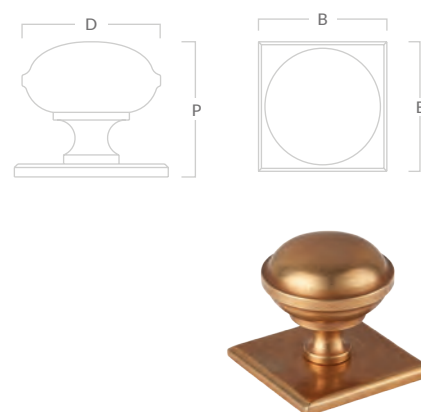

In-situ photographed in our polished brass unlacquered finish. Products photographed in our aged brass (BEL) finish.





### Queslett Cabinet Knob with Rectangular Backplate

Code	Diameter (D)	Plate width (PW)	Plate height (PH)	Projection (P)
QKR/28	28mm	63mm	32mm	30mm
QKR/34	34mm	77mm	38mm	36mm
QKR/40	40mm	90mm	44mm	39mm
QKR/45	45mm	102mm	51mm	40mm



### Queslett Finger & Cup Pull

Code	Height (H)	Length (L)	Centres (C1)	Centres (C2)	Projection (P)
Q40	40mm	64mm	40mm	n/a	22mm
Q96	40mm	108mm	96mm	n/a	22mm
Q120	40mm	160mm	120mm	n/a	22mm
Q203	40mm	229mm	203mm	n/a	22mm
Q288	40mm	330mm	288mm	144mm	22mm
Q384	40mm	432mm	384mm	192mm	22mm

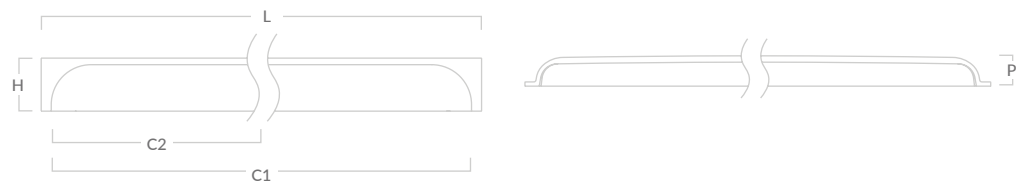



# Withenshaw collection

Classic

The smooth curves of the Withenshaw collection add instant character.



## Withenshaw Cabinet Knob

Code	Diameter (D)	Projection (P)	Base (B)
WITK/32	32mm	32mm	24mm
WITK/38	38mm	39mm	28mm

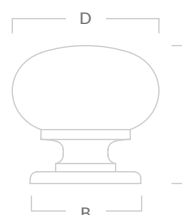

## Withenshaw Cup Pull

Code	Length (L)	Centres (C)	Projection (P)	Height (H)
WIT/96	127mm	96mm	22mm	41mm
WIT/192	224mm	192mm	22mm	41mm

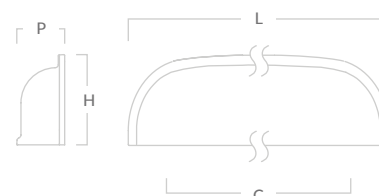

All products photographed in our aged brass (BEL) finish.

# Washwood collection

Classic

Fluid in appearance, the Washwood collection has a timeless beauty.



## Washwood Cabinet Knob

Code	Diameter (D)	Projection (P)	Base (B)
WAS/KNOBONLY/35	35mm	32mm	18mm

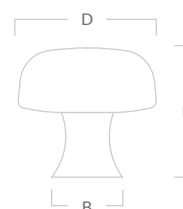

## Washwood Cabinet Knob with Backplate

Code	Width (W)	Projection (P)	Centres (C)	Knob diameter
WAS/35	60mm	37mm	44mm	35mm

Knob has both front and rear fixings

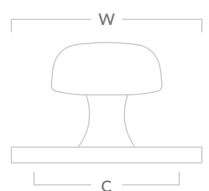

## Washwood Cabinet & Appliance Handle

Code	Centres (C)	Length (L)	Projection (P)	Bar Width
WAS/96	96mm	109mm	27mm	13x7mm
WAS/152	152mm	170mm	35mm	17x9mm
WAS/224*	224mm	246mm	45mm	22x12mm
WAS/APP/384*	359mm	384mm	52mm	25x14mm

\*Pulls have both front and rear fixings

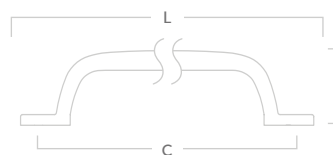

In-situ photographed in our aged brass (BEL) finish. Products photographed in our satin antique satin lacquered (SAS) finish.







## Speciality *collection*

This category features our mid-tier priced collections. Choose from a selection of products that are precision CNC machined before being hand-finished and hand-assembled by our skilled makers.

# Bromford collection

Contemporary

The Bromford collection makes an impact in modern homes with bold lines at the forefront of each handle design.



## Bromford Cabinet Knob

Code	Width (W)	Projection (P)	Base (B)
BRMK/32	32mm	33mm	25mm

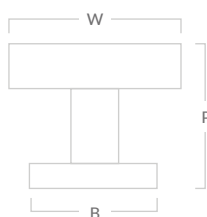

## Bromford Drop Handle

Code	Width (W)	Projection (P)	Length (L)
BRMD/60	25mm	22mm	68mm

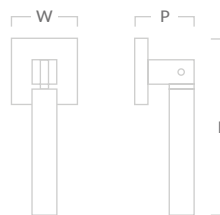

## Bromford Cabinet & Appliance Handle

Code	Length (L)	Centres (C)	Projection (P)	Square bar
BRM/96	121mm	96mm	31mm	9.5mm
BRM/128	153mm	128mm	31mm	9.5mm
BRM/203	228mm	203mm	33mm	9.5mm
BRM/305	337mm	305mm	42mm	12.7mm
BRM/APP/381	419mm	381mm	46mm	16mm
BRM/APP/608	646mm	608mm	46mm	16mm



All products photographed in our satin antique satin lacquered (SAS) finish.

# Kingsheath collection

Contemporary

Embracing a simple but significant design aesthetic, the Kingsheath collection harnesses the beauty of cylindrical shapes.



## Kingsheath Cabinet Knob

Code	Diameter (D)	Projection (P)	Base (B)
KIN/32	32mm	32mm	24mm

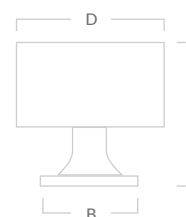

## Kingsheath T-bar Handle

Code	Width (W)	Projection (P)	Base (B)	Bar diameter
KINT/55	55mm	35mm	24mm	16mm

Not suitable for appliance doors

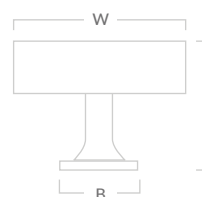

## Kingsheath Cabinet & Appliance Handle

Code	Length (L)	Centres (C)	Projection (P)	Bar diameter
KIN/128	168mm	128mm	33mm	11mm
KIN/160	210mm	160mm	36mm	14mm
KIN/224	274mm	224mm	36mm	14mm
KIN/228	338mm	288mm	46mm	14mm
KIN/APP/384	444mm	384mm	49mm	18mm
KIN/APP/608	668mm	608mm	49mm	18mm

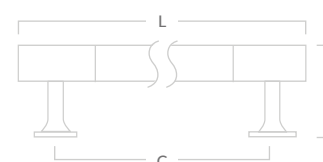

In-situ photographed in our dark bronze (DBZ) finish. Product photographed in our aged brass (BEL) finish.



# Sparkbrook collection

Contemporary

For spaces favouring subtle industrial design accents, the Sparkbrook collection features a machined diamond knurl for a textured look.



## Sparkbrook Cabinet Knob

Code	Diameter (D)	Projection (P)	Base (B)
SPA/32	32mm	32mm	24mm



## Sparkbrook T-bar Handle

Code	Width (W)	Projection (P)	Base (B)	Bar diameter
SPAT/55	55mm	35mm	24mm	16mm

Not suitable for appliance doors

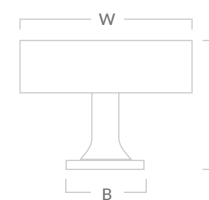

## Sparkbrook Cabinet & Appliance Handle

Code	Length (L)	Centres (C)	Projection (P)	Bar diameter
SPA/128	168mm	128mm	33mm	11mm
SPA/160	210mm	160mm	36mm	14mm
SPA/224	274mm	224mm	36mm	14mm
SPA/228	338mm	288mm	36mm	14mm
SPA/APP/384	444mm	384mm	49mm	18mm
SPA/APP/608	668mm	608mm	49mm	18mm

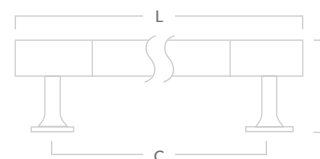

In-situ photographed in our satin antique satin lacquered (SAS) finish. Product photographed in our satin brass satin lacquered finish.





# Leebank collection

Contemporary

Stylish and modern, the Leebank collection features a machined straight knurl for a design-forward ridged look.



## Leebank Cabinet Knob

Code	Diameter (D)	Projection (P)	Base (B)
LEEK/32	32mm	32mm	24mm



## Leebank T-bar Handle

Code	Width (W)	Projection (P)	Base (B)	Bar diameter
LEET/55	55mm	35mm	24mm	16mm

Not suitable for appliance doors

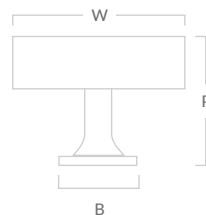

## Leebank Cabinet & Appliance Handle

Code	Length (L)	Centres (C)	Projection (P)	Bar diameter
LEE/128	168mm	128mm	33mm	11mm
LEE/160	210mm	160mm	36mm	14mm
LEE/224	274mm	224mm	36mm	14mm
LEE/228	338mm	288mm	46mm	14mm
LEE/APP/384	444mm	384mm	49mm	18mm
LEE/APP/608	668mm	608mm	49mm	18mm

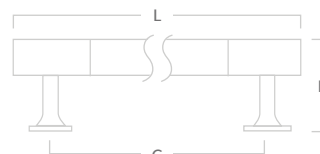

In-situ photographed in our aged brass (BEL) finish. Product photographed in our satin antique satin lacquered (SAS) finish.



# Carlton collection

Classic

Yielding a deco look, the Carlton collection features an elegant stepped edge for subtle definition.



## Carlton Cabinet Knob

Code	Diameter (D)	Projection (P)	Base (B)
CARK/25	25mm	25mm	16mm
CARK/30	30mm	30mm	19mm
CARK/35	35mm	35mm	22mm



## Carlton Cabinet Handle

Code	Length (L)	Centres (C)	Projection (P)	Bar diameter
CAR/96	114mm	96mm	36mm	12.7mm
CAR/128	146mm	128mm	36mm	12.7mm
CAR/160	178mm	160mm	36mm	12.7mm
CAR/224	242mm	224mm	36mm	12.7mm
CAR/304	322mm	304mm	36mm	12.7mm



## Carlton Appliance Handle

Code	Length (L)	Centres (C)	Projection (P)	Bar diameter
CAR/APP/368	395mm	368mm	54mm	19mm
CAR/APP/608	635mm	608mm	54mm	19mm



In-situ photographed in our satin antique satin lacquered (SAS) finish. Product photographed in our aged brass (BEL) finish.

# Lincoln collection

Classic

Stepped edges accentuate the timeless design of the Lincoln collection.



## Lincoln Cabinet Knob

Code	Projection (P)	Diameter (D)	Base (B)
LINK/25	20mm	25mm	16mm
LINK/32	26mm	32mm	20mm
LINK/38	30mm	38mm	24mm

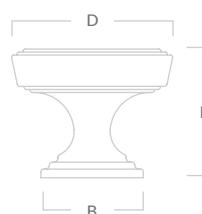

## Lincoln T-bar Handle

Code	Width (W)	Projection (P)	Base (B)	Bar diameter
LINT/82	82mm	34mm	24mm	12.7mm

Not suitable for appliance doors

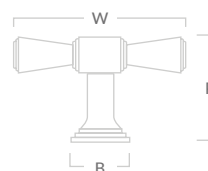

## Lincoln Cabinet & Appliance Handle

Code	Length (L)	Centres (C)	Projection (P)	Bar diameter
LIN/96	186mm	96mm	35mm	12.7mm
LIN/128	218mm	128mm	35mm	12.7mm
LIN/224	361mm	224mm	42mm	16mm
LIN/APP/304	470mm	304mm	49mm	19mm
LIN/APP/608	774mm	608mm	49mm	19mm

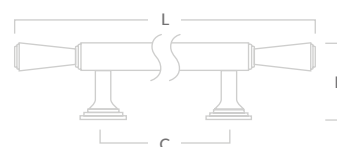

In-situ photographed in our polished nickel plate (PNP) finish. Product photographed in our satin antique satin lacquered (SAS) finish.

# Rotunda collection

Classic

For deco-inspired spaces, opt for the Rotunda collection to dress cabinets and furniture.



## Rotunda Cabinet Knob

Code	Diameter (D)	Projection (P)	Base (B)
ROTK/25	25mm	24mm	15mm
ROTK/32	32mm	27mm	17mm
ROTK/38	38mm	30mm	20mm
ROTK/50	50mm	32mm	26mm

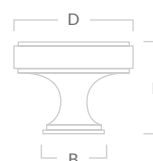

## Rotunda Cabinet Handle

Code	Length (L)	Centres (C)	Projection (P)	Bar width
ROT/96	160mm	96mm	34mm	16x9.5mm
ROT/128	192mm	128mm	34mm	16x9.5mm
ROT/160	224mm	160mm	34mm	16x9.5mm
ROT/224	288mm	224mm	34mm	16x9.5mm
ROT/228	352mm	288mm	34mm	16x9.5mm

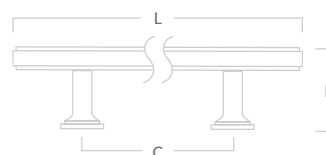

## Rotunda Appliance Handle

Code	Length (L)	Centres (C)	Projection (P)	Bar width
ROT/APP/352	428mm	352mm	43mm	19x12.7mm
ROT/APP/608	684mm	608mm	43mm	19x12.7mm



In-situ photographed in our aged brass (BEL) finish. Product photographed in our dark bronze (DBZ) finish.



# Jefferson collection

Classic

Inspired by the deco design era, the Jefferson collection features angled edges and a stepped design.



## Jefferson Cabinet Knob

Code	Width (W)	Projection (P)	Base (B)
JEFK/25	25mm	29mm	19mm
JEFK/32	32mm	33mm	24mm
JEFK/38	38mm	33mm	24mm

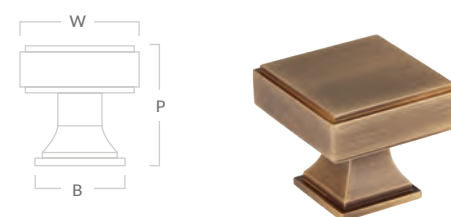

## Jefferson Cabinet Handle

Code	Length (L)	Centres (C)	Projection (P)	Bar width
JEF/96	109mm	96mm	30mm	12.7x9.5mm
JEF/102	126mm	102mm	30mm	16x9.5mm
JEF/152	176mm	152mm	30mm	16x9.5mm
JEF/203	227mm	203mm	30mm	16x9.5mm
JEF/305	335mm	305mm	40mm	19x12.7mm

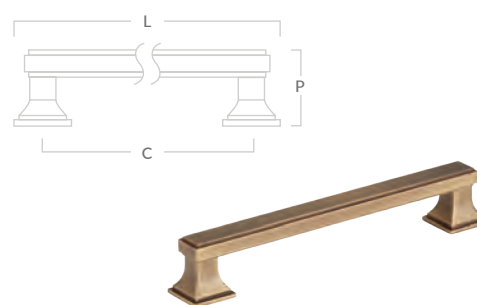

## Jefferson Appliance Handle

Code	Length (L)	Centres (C)	Projection (P)	Bar width
JEF/APP/368	398mm	368mm	40mm	19x12.7mm
JEF/APP/608	638mm	608mm	40mm	19x12.7mm

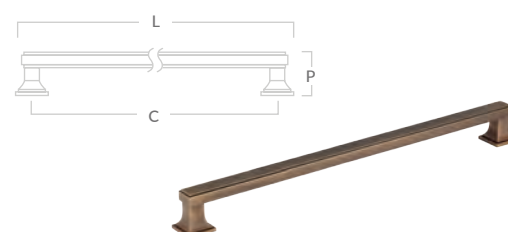

All products photographed in our satin antique satin lacquered (SAS) finish.

# Gaumont collection

Classic

With a nod to the deco design era, Gaumont features a slight stepped edge to each piece of hardware.



## Gaumont T-bar Handle

Code	Width (W)	Projection (P)	Base (B)	Bar diameter
GAUT/64	64mm	36mm	18mm	12.7mm

Not suitable for appliance doors

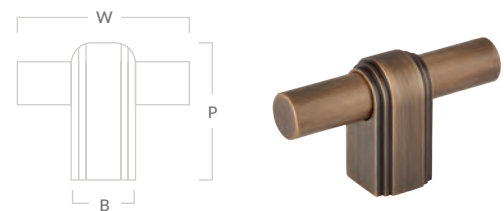

## Gaumont Cabinet Handle

Code	Length (L)	Centres (C)	Projection (P)	Bar width
GAU/96	150mm	96mm	36mm	12.7mm
GAU/128	182mm	128mm	36mm	12.7mm
GAU/160	214mm	160mm	36mm	12.7mm
GAU/224	278mm	224mm	36mm	12.7mm
GAU/304	358mm	304mm	36mm	12.7mm

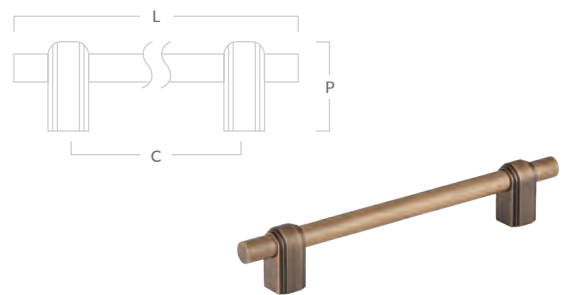

## Gaumont Appliance Handle

Code	Length (L)	Centres (C)	Projection (P)	Bar width
GAU/APP/368	430mm	368mm	54mm	19mm
GAU/APP/368	670mm	608mm	54mm	19mm

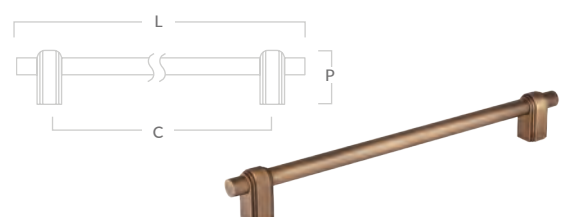

All products photographed in our satin antique satin lacquered (SAS) finish.

# Sutton collection

Classic

The Sutton collection features sleek circular grooves to bring definition to timeless designs.



## Sutton Cabinet Knob

Code	Diameter (D)	Projection (P)	Base (B)
SUTK/25	25mm	25mm	16mm
SUTK/32	32mm	29mm	21mm
SUTK/38	38mm	33mm	25mm
SUTK/50	50mm	33mm	27mm

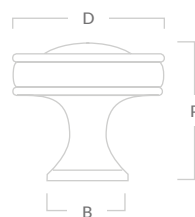

## Sutton Cabinet Handle

Code	Length (L)	Centres (C)	Projection (P)	Bar diameter
SUT/96	160mm	96mm	39mm	16mm
SUT/128	192mm	128mm	39mm	16mm
SUT/160	224mm	160mm	39mm	16mm
SUT/224	305mm	224mm	46mm	19mm

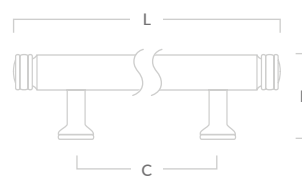

## Sutton Appliance Handle

Code	Length (L)	Centres (C)	Projection (P)	Bar diameter
SUT/APP/368	438mm	368mm	49mm	19mm
SUT/APP/608	678mm	608mm	49mm	19mm

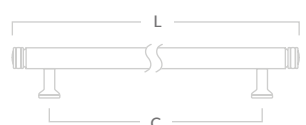

In-situ photographed in our aged brass (BEL) finish. Product photographed in our dark bronze (DBZ) finish.



# Belgrave collection

Classic

Elegant and sophisticated, bring harmony to opulent settings with the Belgrave collection.



## Belgrave Cabinet Knob

Code	Diameter (D)	Projection (P)	Base (B)
BELK/25	25mm	29mm	15mm
BELK/32	32mm	36mm	19mm
BELK/38	38mm	43mm	22mm



## Belgrave T-bar Handle

Code	Width (W)	Projection (P)	Base (B)
BELT/61	61mm	49mm	22mm

Not suitable for appliance doors

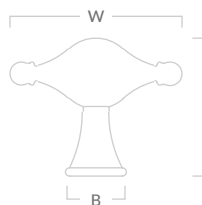

## Belgrave Cabinet & Appliance Handle

Code	Length (L)	Centres (C)	Projection (P)	Bar diameter
BEL/128	177mm	128mm	40mm	12.7mm
BEL/160	208mm	160mm	40mm	12.7mm
BEL/192	240mm	192mm	40mm	12.7mm
BEL/256	317mm	256mm	50mm	16mm
BEL/384	445mm	384mm	50mm	16mm
BEL/APP/448	521mm	448mm	57mm	19mm
BEL/APP/608	681mm	608mm	57mm	19mm

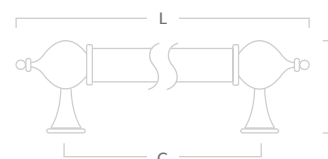

In-situ photographed in our satin brass lacquered (SBL) finish. Product photographed in our dark bronze (DBZ) finish.

# Snowdrift collection

Classic

Add a softness to minimal spaces with the curved contours of the Snowdrift collection.



## Snowdrift Cabinet Knob

Code	Width (W)	Projection (P)	Base (B)	Depth (D)
DRFTK	46mm	30mm	36X19mm	27mm

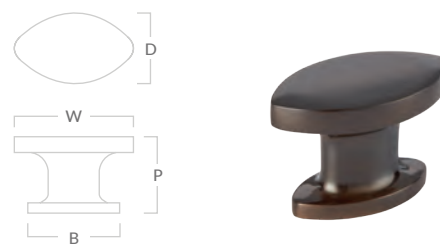

## Snowdrift Cabinet Pull

Code	Length (L)	Centres (C)	Height (H)	Projection (P)
DRFT/107	107mm	64mm	32mm	25mm
DRFT/187	187mm	160mm	36mm	25mm
DRFT/280	280mm	224mm	40mm	25mm

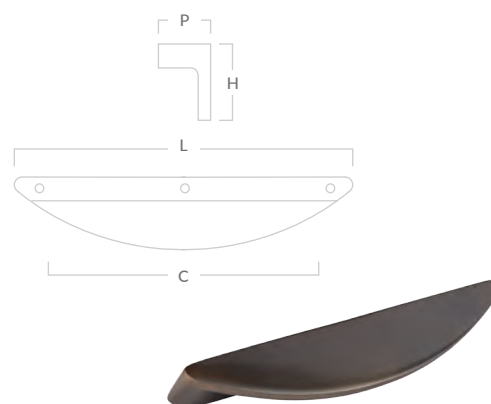

In-situ photographed in our satin antique satin lacquered (SAS) finish. Product photographed in our dark bronze (DBZ) finish.

# Merrick collection

Classic

Showcasing a sophisticated reeded design, the Merrick collection adds instant texture.



## Merrick Cabinet Knob

Code	Diameter (D)	Projection (P)	Base (B)
MERK/19	19mm	28mm	19mm
MERK/25	25mm	38mm	25mm
MERK/32	32mm	43mm	32mm
MERK/38	38mm	54mm	38mm

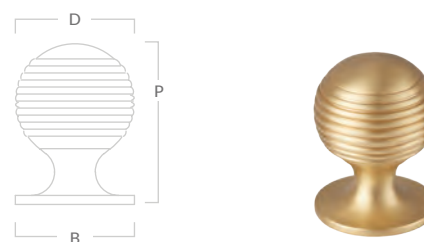

## Merrick Cabinet Handle

Code	Length (L)	Centres (C)	Projection (P)	Bar diameter
MER/96	202mm	96mm	39mm	16mm
MER/128	234mm	128mm	39mm	16mm
MER/160	266mm	160mm	39mm	16mm
MER/224	330mm	224mm	39mm	16mm
MER/288	394mm	288mm	39mm	16mm

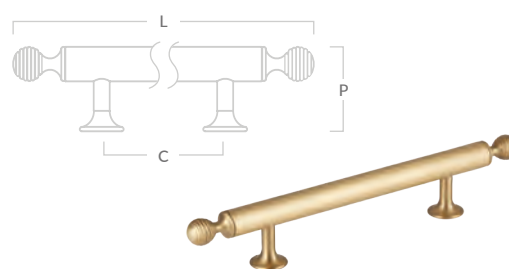

## Merrick Appliance Handle

Code	Length (L)	Centres (C)	Projection (P)	Bar diameter
MER/APP/368	478mm	368mm	49mm	19mm
MER/APP/608	718mm	608mm	49mm	19mm

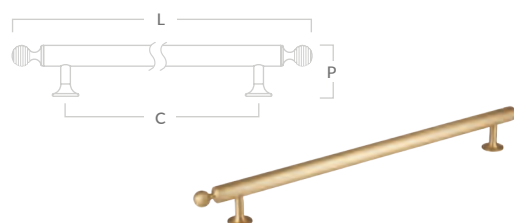

In-situ photographed in our polished brass lacquered (PBL) finish. Product photographed in our satin brass satin lacquered (SBSL) finish.



# Latchford collection

Classic

Expertly machined, the Latchford collection nods to a more traditional aesthetic with a curved design and flawless surface.



## Latchford Cabinet Knob

Code	Diameter (D)	Projection (P)	Base (B)
LATK/25	25mm	38mm	25mm
LATK/30	30mm	45mm	30mm
LATK/35	35mm	53mm	35mm

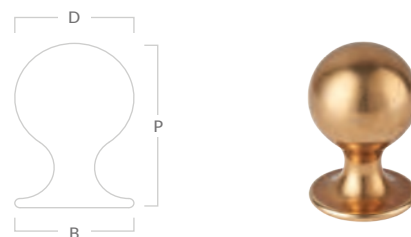

## Latchford Cabinet Handle

Code	Length (L)	Centres (C)	Projection (P)	Bar diameter
LAT/96	202mm	96mm	39mm	16mm
LAT/128	234mm	128mm	39mm	16mm
LAT/160	266mm	160mm	39mm	16mm
LAT/224	330mm	224mm	39mm	16mm
LAT/288	394mm	288mm	39mm	16mm

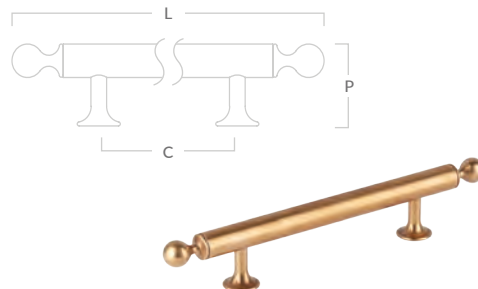

## Latchford Appliance Handle

Code	Length (L)	Centres (C)	Projection (P)	Bar diameter
LAT/APP/368	479mm	368mm	49mm	19mm
LAT/APP/608	719mm	608mm	49mm	19mm

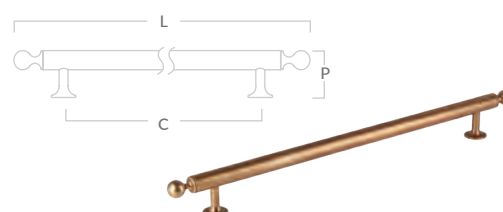

In-situ photographed in our polished nickel plate (PNP) finish. Product photographed in our aged brass (BEL) finish.





Our Latchford collection photographed in our dark bronze (DBZ) finish.

# Colmore *collection*

Classic

Showcasing impeccably smooth contours with subtle concave details, the iconic martini glass profile leads the design of our Colmore collection.



## Colmore Cabinet Knob

Code	Diameter (D)	Projection (P)	Base (B)
COLK/27	27mm	27mm	16mm
COLK/32	32mm	32mm	23mm
COLK/38	38mm	38mm	26mm
COLK/45	45mm	40mm	32mm



## Colmore Hook

Code	Diameter (D)	Projection (P)	Base (B)
COL/HOOK/27	27mm	27mm	16mm
COL/HOOK/32	32mm	32mm	23mm
COL/HOOK/38	38mm	38mm	26mm
COL/HOOK/45	45mm	40mm	32mm



Creative photographed in our polished brass lacquered (PBL) finish. Product photographed in our aged brass (BEL) finish.



## Colmore Cabinet & Appliance Handle

Code	Centres (C)	Bar Diameter	Length (L)	Projection (P)
COL/96	96mm	15mm	118mm	38mm
COL/128	128mm	15mm	150mm	38mm
COL/160	160mm	15mm	182mm	38mm
COL/224	224mm	15mm	246mm	38mm
COL/288	288mm	15mm	310mm	38mm
COL/APP/384	384mm	18mm	408mm	43mm
COL/APP/608	608mm	18mm	632mm	43mm

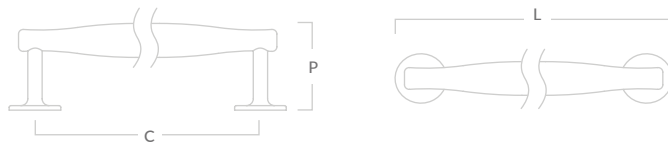

## Colmore Cabinet Capsule Handle

Code	Centres (C)	Length (L)	Width (W)	Projection (P)
COL/CAPSULE/64	64mm	105mm	32mm	25mm
COL/CAPSULE/96	96mm	137mm	32mm	25mm
COL/CAPSULE/128	128mm	169mm	32mm	25mm
COL/CAPSULE/160	160mm	201mm	32mm	25mm
COL/CAPSULE/224	224mm	265mm	32mm	25mm
COL/CAPSULE/288	288mm	329mm	32mm	25mm
COL/CAPSULE/384	384mm	425mm	32mm	25mm
COL/CAPSULE/608	608mm	649mm	32mm	25mm



## Colmore D-Pull Handle

Code	Diameter (D)	Projection (P)	Base (B)	Centres (C)	Width (W)
COL/DPULL/100	100mm	37mm	18mm	28mm	48mm
COL/DPULL/150	150mm	40mm	30mm	50mm	73mm

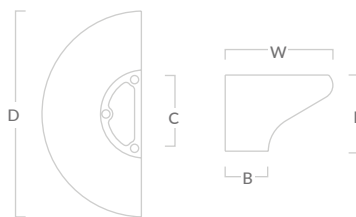

## Colmore Circular Pull Handle

Code	Diameter (D)	Projection (P)	Base (B)	Centres (C)
COL/CIRCULARPULL/100	100mm	37mm	40mm	28mm

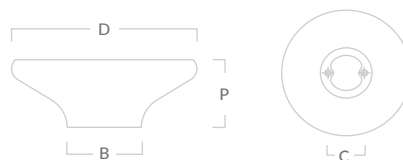





## **Luxe *collection***

This category features our most luxurious collections. Crafted with the highest levels of design and engineering, these pieces are created using uniquely intricate techniques and highly skilled hand-finished touches to assemble multiple components.



# Barwick Ridged *collection*

Contemporary

Effortless column shapes and linear ridges parallel the distinctive form of traditional distillery tanks in our Barwick Ridged collection.



## Barwick Ridged Cabinet Knob

Code	Diameter (D)	Projection (P)	Base (B)
BWKK/KNOBONLY/25	25mm	27mm	13mm
BWKK/KNOBONLY/32	32mm	35mm	14mm
BWKK/KNOBONLY/38	38mm	38mm	15mm
BWKK/KNOBONLY/45	45mm	41mm	16mm

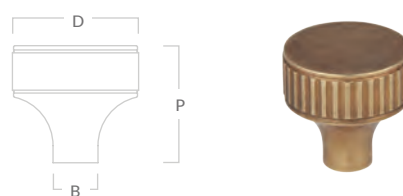

## Barwick Ridged Cabinet Knob with Backplate

Code	Diameter (D)	Projection (P)	Plate length (PL)	Plate width (PW)
BWKK/25	25mm	30mm	62mm	31mm
BWKK/32	32mm	38mm	76mm	38mm
BWKK/38	38mm	41mm	88mm	44mm
BWKK/45	45mm	44mm	108mm	51mm

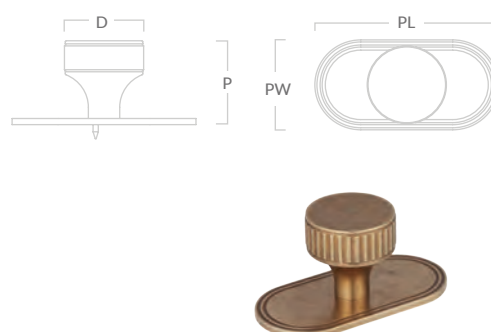

All products photographed in our aged brass (BEL) finish.

### Barwick Ridged T-bar Handle

Code	Diameter (D)	Projection (P)	Length (L)
BWKT/TBARONLY/79	25mm	45mm	79mm

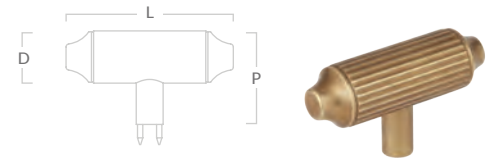

### Barwick Ridged T-bar Handle with Backplate

Code	Diameter (D)	Projection (P)	Plate length (PL)	Plate width (PW)
BWKT/79	25mm	48mm	96mm	38mm

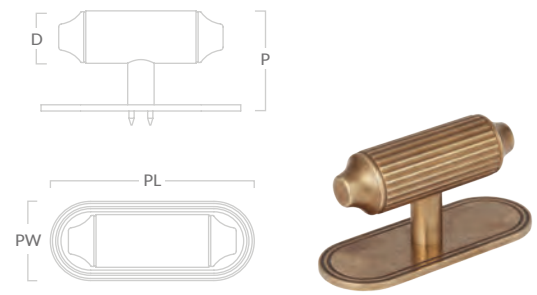

### Barwick Ridged Hook

Code	Diameter (D)	Projection (P)	Base (B)
BWK/HOOKONLY/22	22mm	32mm	13mm

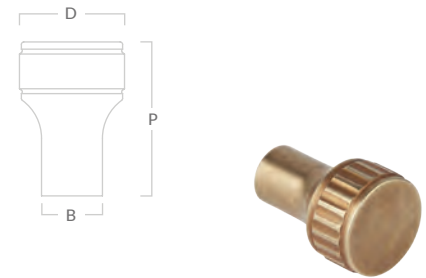

### Barwick Ridged Hook with Backplate

Code	Diameter (D)	Projection (P)	Plate length (PL)	Plate width (PW)
BWK/HOOK/22	22mm	35mm	56mm	28mm



### Barwick Ridged Cabinet & Appliance Handle

Code	Diameter (D)	Projection (P)	Length (L)	Centres (C)
BWK/PULLONLY/128	25mm	48mm	141mm	128mm
BWK/PULLONLY /160	25mm	48mm	173mm	160mm
BWK/PULLONLY /224	25mm	48mm	237mm	224mm
BWK/ PULLONLY/288	25mm	48mm	301mm	288mm
BWK/PULLONLY/APP/384	25mm	48mm	397mm	384mm
BWK/PULLONLY/APP/608	25mm	48mm	621mm	608mm



## Barwick Ridged Cabinet & Appliance Handle with Backplate

Code	Diameter	Projection (P)	Plate length (PL)	Plate width (PW)	Length (L)	Centres (C)
BWK/128	25mm	51mm	179mm	51mm	141mm	128mm
BWK/160	25mm	51mm	211mm	51mm	173mm	160mm
BWK/224	25mm	51mm	275mm	51mm	237mm	224mm
BWK/288	25mm	51mm	339mm	51mm	301mm	288mm
BWK/APP/384	25mm	51mm	435mm	51mm	397mm	384mm
BWK/APP/608	25mm	51mm	659mm	51mm	621mm	608mm



## Barwick Ridged D-Pull Handle

Code	Width (W)	Diameter (D)	Centres (C)	Projection (P)	Base (B)
BWK/DPULL/100	48mm	100mm	33mm	45mm	21mm
BWK/DPULL/150	73mm	150mm	56mm	45mm	32mm

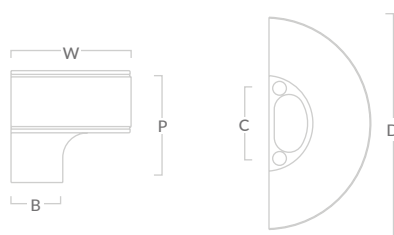

## Barwick Ridged Recess Pull

Code	Width (W)	Projection (P)	Centres (C)	Overall Length (OL)	Underside (U)
BWK/RECESS/100	48mm	13mm	60mm	100mm	16mm
BWK/RECESS/125	61mm	13mm	75mm	125mm	16mm
BWK/RECESS/150	73mm	13mm	96mm	150mm	16mm

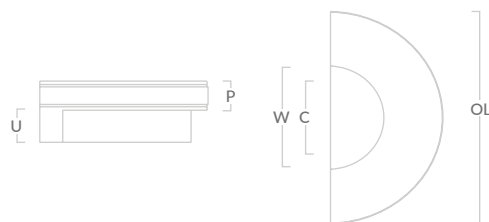



# Barwick Plain *collection*

Contemporary

Presenting a bold and statement look, effortless column shapes parallel the distinctive form of distillery tanks in our Barwick plain collection.



## Barwick Plain Cabinet Knob

Code	Diameter (D)	Projection (P)	Base (B)
BWKK/KNOBONLY/PLAIN/25	25mm	27mm	13mm
BWKK/KNOBONLY/PLAIN/32	32mm	35mm	14mm
BWKK/KNOBONLY/PLAIN/38	38mm	38mm	15mm
BWKK/KNOBONLY/PLAIN/45	45mm	41mm	16mm

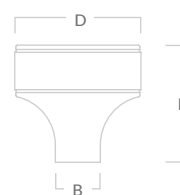

## Barwick Plain Cabinet Knob with Backplate

Code	Diameter (D)	Projection (P)	Plate length (PL)	Plate width (PW)
BWKK/PLAIN/25	25mm	30mm	62mm	31mm
BWKK/PLAIN/32	32mm	38mm	76mm	38mm
BWKK/PLAIN/38	38mm	41mm	88mm	44mm
BWKK/PLAIN/45	45mm	44mm	108mm	51mm



Creative photographed in our polished brass lacquered (PBL) finish. Product photographed in our aged brass (BEL) finish.

### Barwick Plain T-bar Handle

Code	Diameter (D)	Projection (P)	Length (L)
BWKT/TBARONLY/PLAIN/79	25mm	45mm	79mm

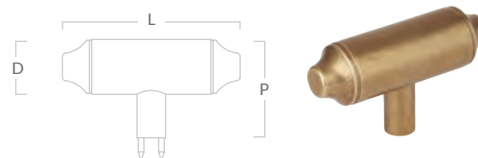

### Barwick Plain T-bar Handle with Backplate

Code	Diameter (D)	Projection (P)	Plate length (PL)	Plate width (PW)
BWKT/TBARONLY/PLAIN/79	25mm	45mm	79mm	38mm

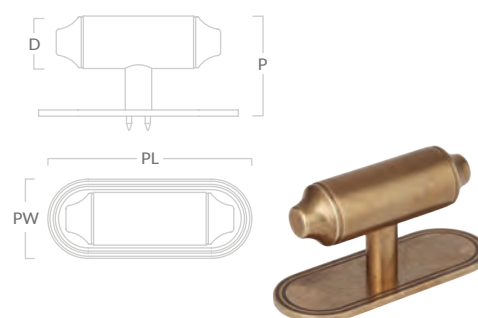

### Barwick Plain Hook

Code	Diameter (D)	Projection (P)	Base (B)
BWK/HOOKONLY/PLAIN/22	22mm	32mm	13mm

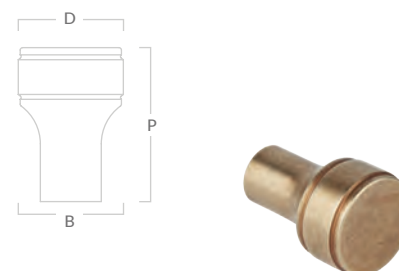

### Barwick Plain Hook with Backplate

Code	Diameter (D)	Projection (P)	Plate length (PL)	Plate width (PW)
BWK/HOOK/PLAIN/22	22mm	35mm	56mm	28mm

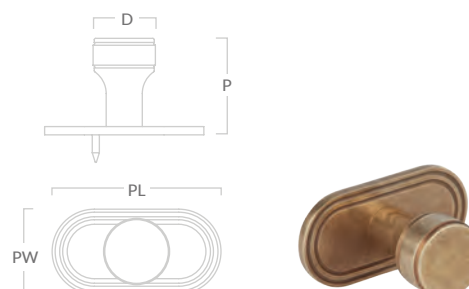

### Barwick Plain Cabinet & Appliance Handle

Code	Diameter (D)	Projection (P)	Length (L)	Centres (C)
BWK/PULLONLY/PLAIN/128	25mm	48mm	141mm	128mm
BWK/PULLONLY/PLAIN/160	25mm	48mm	173mm	160mm
BWK/PULLONLY/PLAIN/224	25mm	48mm	237mm	224mm
BWK/PULLONLY/PLAIN/288	25mm	48mm	301mm	288mm
BWK/PULLONLY/APP/PLAIN/384	25mm	48mm	397mm	384mm
BWK/PULLONLY/APP/PLAIN/608	25mm	48mm	621mm	608mm

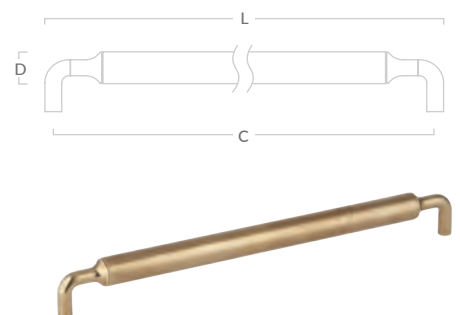

## Barwick Plain Cabinet & Appliance Handle with Backplate

Code	Diameter (D)	Projection (P)	Plate length (PL)	Plate width (PW)	Length (L)	Centres (C)
BWK/PLAIN/128	25mm	51mm	179mm	51mm	141mm	128mm
BWK/PLAIN/160	25mm	51mm	211mm	51mm	173mm	160mm
BWK/PLAIN/224	25mm	51mm	275mm	51mm	237mm	224mm
BWK/PLAIN/288	25mm	51mm	339mm	51mm	301mm	288mm
BWK/APP/PLAIN/384	25mm	51mm	435mm	51mm	397mm	384mm
BWK/APP/PLAIN/608	25mm	51mm	659mm	51mm	621mm	608mm

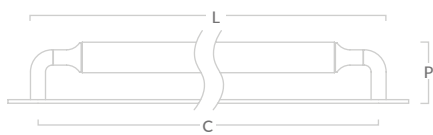

## Barwick Plain D-Pull Handle

Code	Width (W)	Diameter (D)	Centres (C)	Projection (P)	Base (B)
BWK/DPULL/PLAIN/100	48mm	100mm	33mm	45mm	21mm
BWK/DPULL/PLAIN/150	73mm	150mm	56mm	45mm	32mm

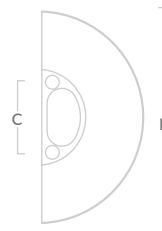
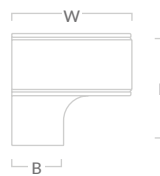

## Barwick Plain Recess Pull

Code	Width (W)	Projection (P)	Centres (C)	Overall Length (OL)	Underside (U)
BWK/RECESS/PLAIN/100	48mm	13mm	60mm	100mm	16mm
BWK/RECESS/PLAIN/125	61mm	13mm	75mm	125mm	16mm
BWK/RECESS/PLAIN/150	73mm	13mm	96mm	150mm	16mm

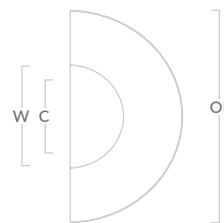



# Digbeth Ridged collection

Contemporary

Presenting industrial design-led style, the Digbeth collection echoes the raw textures of a bold district and features hand-finished linear ridged details to the surface.



## Digbeth Ridged Cabinet Knob

Code	Width sq. (W)	Projection (P)
DIGK/KNOBONLY/32	32mm	31mm
DIGK/KNOBONLY/38	38mm	33mm

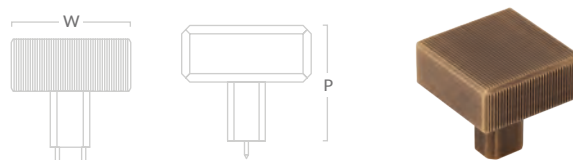

## Digbeth Ridged Cabinet Knob with Backplate

Code	Width sq. (W)	Projection (P)	Plate width sq. (PW)
DIGK/32	32mm	35mm	38mm
DIGK/38	38mm	38mm	45mm

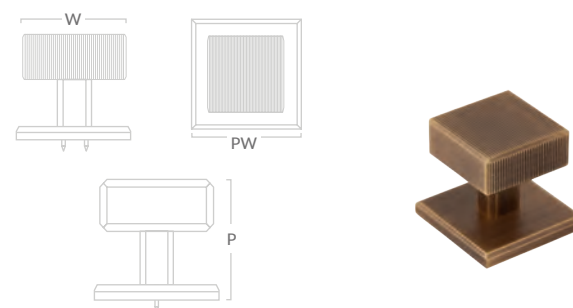

## Digbeth Ridged T-bar Handle

Code	Length (L)	Width sq. (W)	Projection (P)
DIGT/TBARONLY/67	67mm	16mm	33mm

Not suitable for appliance doors

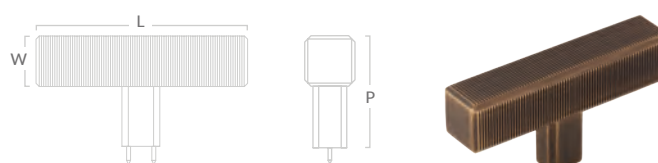

In-situ photographed in our aged brass (BEL) finish. Product photographed in our satin antique satin lacquered (SAS) finish.

### Digbeth Ridged T-bar Handle with Backplate

Code	Projection (P)	Plate length (PL)	Plate width (PW)
DIGT/67	38mm	77mm	25mm

Not suitable for appliance doors

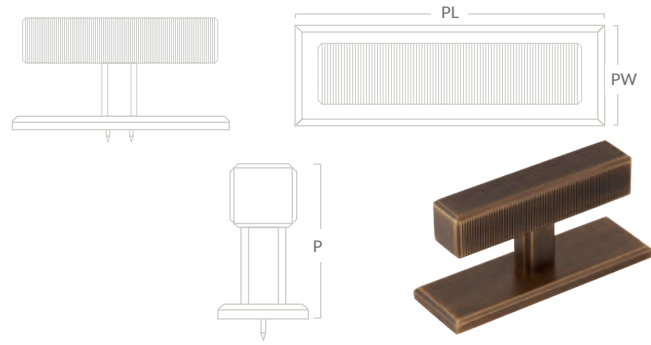

### Digbeth Ridged Cabinet & Appliance Handle

Code	Centres (C)	Length (L)	Width sq. (W)	Projection (P)
DIG/PULLONLY/128	128mm	182mm	12.7mm	33mm
DIG/PULLONLY/160	160mm	217mm	16mm	39mm
DIG/PULLONLY/224	224mm	291mm	16mm	39mm
DIG/PULLONLY/288	288mm	355mm	16mm	39mm
DIG/PULLONLY/APP/384	384mm	461mm	19mm	49mm
DIG/PULLONLY/APP/608	608mm	685mm	19mm	49mm

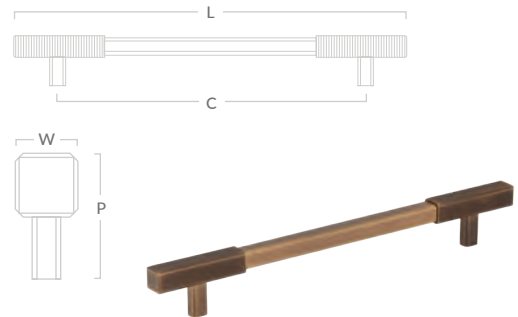

### Digbeth Ridged Cabinet & Appliance Handle with Backplate

Code	Centres (C)	Projection (P)	Plate length (PL)	Plate width (PW)
DIG/128	128mm	37mm	191mm	22mm
DIG/160	160mm	45mm	227mm	25mm
DIG/224	224mm	45mm	301mm	25mm
DIG/288	288mm	45mm	365mm	25mm
DIG/APP/384	384mm	55mm	474mm	32mm
DIG/APP/608	608mm	55mm	698mm	32mm

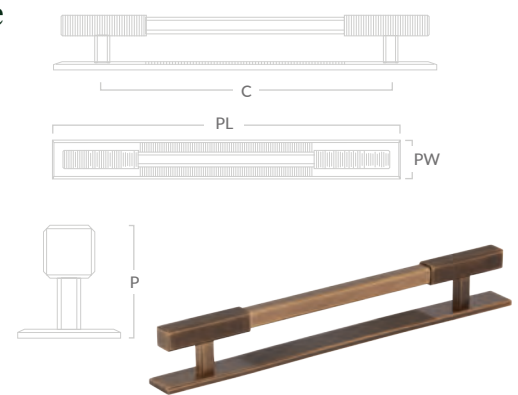

### Digbeth Ridged Hook

Code	Projection (P)	Plate width (PW)	Plate length (PL)
DIG/HOOK/48	39mm	25mm	58mm

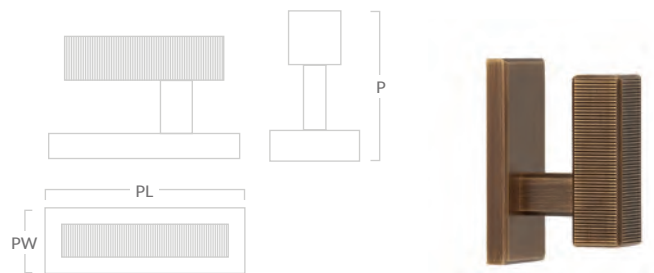

### Digbeth Ridged Latch

Code	Projection (P)	Length (L)	Plate width (PW)	Plate length (PL)
DIG/LATCH/FLUSH/45	20mm	108mm	45mm	64mm
DIG/LATCH/FLUSH/55	30mm	153mm	55mm	81mm

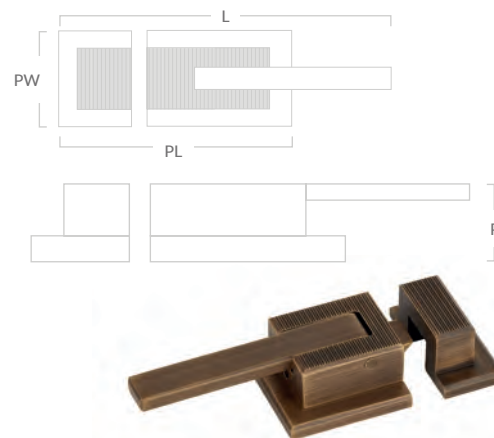

# Digbeth Plain collection

Contemporary

The Digbeth collection is also available in a plain design, yielding a distinctive contemporary look and feel.



## Digbeth Plain Cabinet Knob

Code	Width sq. (W)	Projection (P)
DIGK/KNOBONLY/PLAIN/32	32mm	31mm
DIGK/KNOBONLY/PLAIN/38	38mm	33mm

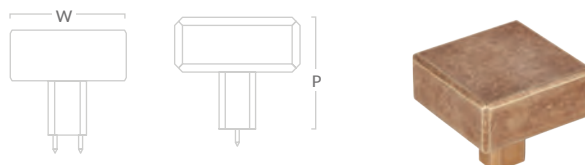

## Digbeth Plain Cabinet Knob with Backplate

Code	Width sq. (W)	Projection (P)	Plate width sq. (PW)
DIGK/PLAIN/32	32mm	35mm	38mm
DIGK/PLAIN/38	38mm	38mm	45mm

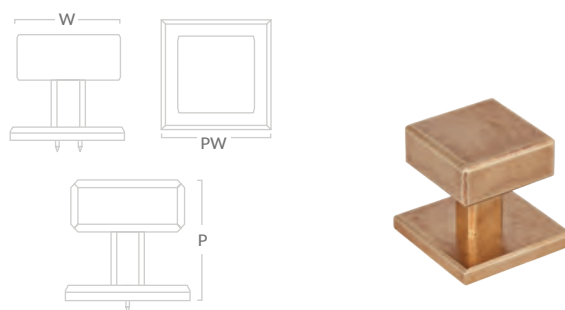

## Digbeth Plain T-bar Handle

Code	Length (L)	Width sq. (W)	Projection (P)
DIGT/TBARONLY/PLAIN/67	67mm	16mm	33mm

Not suitable for appliance doors

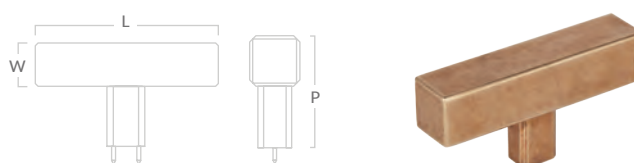

All product photographed in our aged brass (BEL) finish.



### Digbeth Plain T-bar Handle with Backplate

Code	Projection (P)	Plate length (PL)	Plate width (W)
DIGT/PLAIN/67	38mm	77mm	25mm

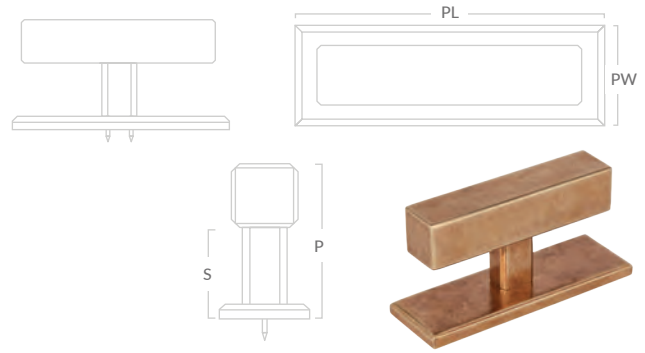

### Digbeth Plain Cabinet & Appliance Handle

Code	Centres (C)	Length (L)	Width sq. (W)	Projection (P)
DIG/PULLONLY/PLAIN/128	128mm	182mm	12.7mm	33mm
DIG/PULLONLY/PLAIN/160	160mm	217mm	16mm	39mm
DIG/PULLONLY/PLAIN/224	224mm	291mm	16mm	39mm
DIG/PULLONLY/PLAIN/288	288mm	355mm	16mm	39mm
DIG/PULLONLY/PLAIN/APP/384	384mm	461mm	19mm	49mm
DIG/PULLONLY/PLAIN/APP/608	608mm	685mm	19mm	49mm

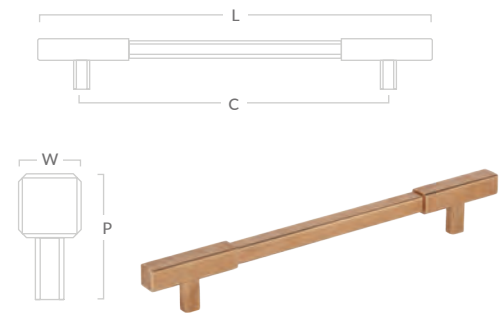

### Digbeth Plain Cabinet & Appliance Handle with Backplate

Code	Centres (C)	Projection (P)	Plate length (PL)	Plate width (PW)
DIG/PLAIN/128	128mm	37mm	191mm	22mm
DIG/PLAIN/160	160mm	45mm	227mm	25mm
DIG/PLAIN/224	224mm	45mm	301mm	25mm
DIG/PLAIN/288	288mm	45mm	365mm	25mm
DIG/PLAIN/APP/384	384mm	55mm	474mm	32mm
DIG/PLAIN/APP/608	608mm	55mm	698mm	32mm

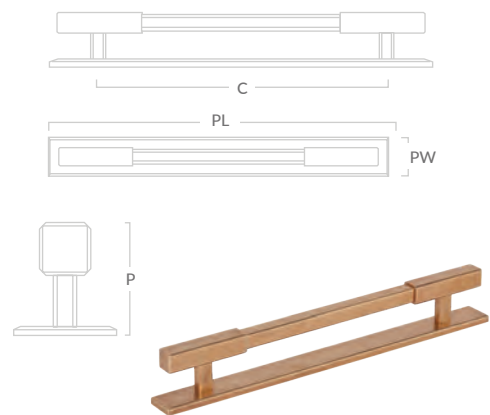

### Digbeth Plain Hook

Code	Projection (P)	Plate width (PW)	Plate length (PL)
DIG/HOOK/PLAIN/48	39mm	25mm	58mm

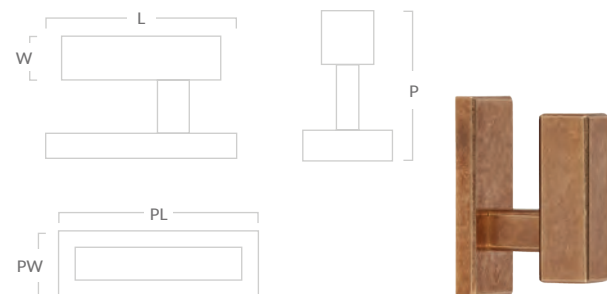

### Digbeth Plain Latch

Code	Projection (P)	Length (L)	Plate width (PW)	Plate length (PL)
DIG/LATCH/FLUSH/PLAIN/45	20mm	108mm	45mm	64mm
DIG/LATCH/FLUSH/PLAIN/55	30mm	153mm	55mm	81mm

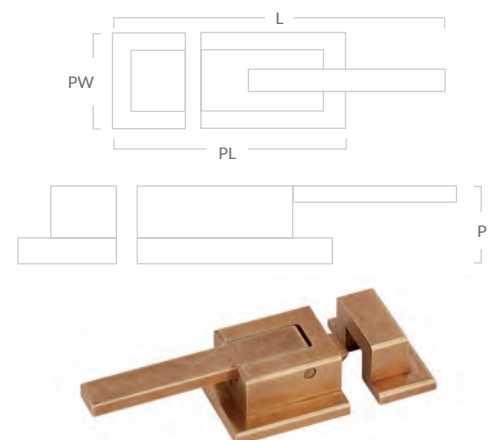

# MIX Diamond collection

Contemporary

'Made by us. Mixed by you.'

The MIX collection is an innovative range of interchangeable cabinet hardware that gives you more control over your design.



## MIX Diamond Cabinet Knob

Code	Diameter (Dia)	Projection (P)	Base (B)
MIX1/KNOBONLY/32	32mm	29mm	10mm

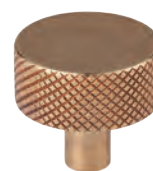
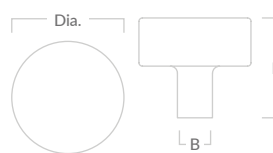

## MIX Diamond Cabinet Knob with Backplate

Code	Centres (C)	Diameter (Dia)	Projection (P)	Plate width (PW)	Plate length (PL)
MIX1/54	54mm	32mm	34mm	25mm	80mm
MIX1/128	128mm	32mm	34mm	25mm	154mm
MIX1/192	192mm	32mm	34mm	25mm	218mm

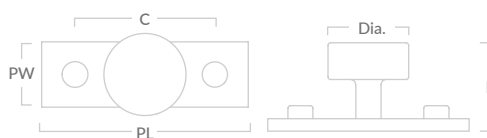

## MIX Diamond Cabinet & Appliance Handle

Code	Centres (C)	Bar diameter	Projection (P)	Length (L)
MIX1/PULLONLY/128	128mm	11mm	34mm	170mm
MIX1/PULLONLY/160	160mm	11mm	34mm	202mm
MIX1/PULLONLY/224	224mm	14mm	37mm	274mm
MIX1/PULLONLY/288	288mm	14mm	37mm	338mm
MIX1/PULLONLY/APP/384	384mm	18mm	50mm	434mm
MIX1/PULLONLY/APP/608	608mm	18mm	50mm	658mm

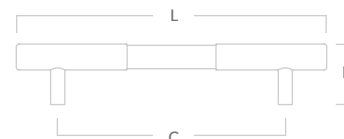

In-situ photographed in our matt black lacquered (MBL) & aged brass (BEL) finish. Product photographed in our aged brass (BEL) finish.

## MIX Diamond Cabinet & Appliance Handle with Backplate

Code	Centres (C)	Bar diameter	Projection (P)	Plate length (PL)	Plate width (PW)
MIX1/PULL/128	128mm	11mm	39mm	198mm	25mm
MIX1/160	160mm	11mm	39mm	230mm	25mm
MIX1/224	224mm	14mm	42mm	310mm	32mm
MIX1/288	288mm	14mm	42mm	374mm	32mm
MIX1/APP/384	384mm	18mm	56mm	470mm	35mm
MIX1/APP/608	608mm	18mm	56mm	694mm	35mm

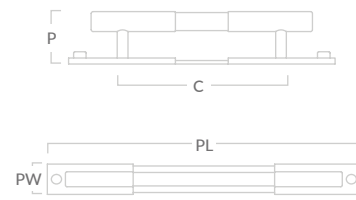

## MIX Diamond T-bar

Code	Centres (C)	Bar diameter	Projection (P)	Plate length (PL)	Plate width (PW)
MIX1T/65	83mm	16mm	38mm	101mm	32mm

Not suitable for appliance doors



## MIX Diamond Wall Hook Rack

Code	Centres (C1)	Centres (C2)	Bar diameter	Plate length (PL)	Projection (P)	Plate width (W)	Length (L)	Hooks
MIX1/HOOK/384	108mm	150mm	16mm	384mm	38mm	32mm	51mm	3
MIX1/HOOK/684	108mm	150mm	16mm	684mm	38mm	32mm	51mm	5

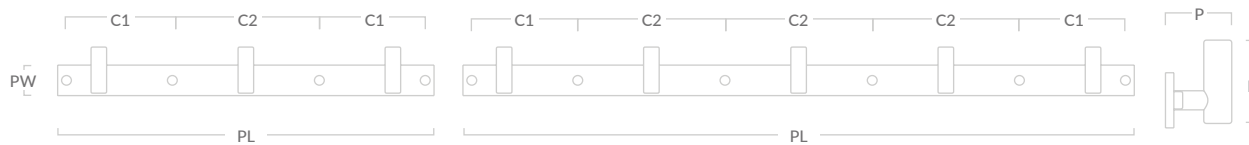

## MIX Diamond Single Vertical Wall Hook

Code	Centres (C)	Bar diameter	Length (L)	Plate length (PL)	Projection (P)	Plate width (PW)
MIX1/V/HOOK/84	66mm	16mm	48mm	84mm	38mm	32mm

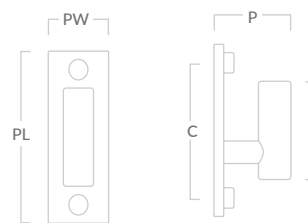

## MIX Diamond Single Horizontal Wall Hook

Code	Centres (C)	Bar diameter	Length (L)	Plate length (PL)	Projection (P)	Plate width (PW)
MIX1/H/HOOK/84	66mm	16mm	48mm	84mm	38mm	32mm

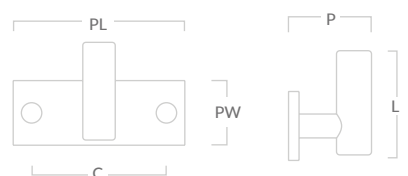



# MIX Straight collection

Contemporary

'Made by us. Mixed by you.'

The MIX collection is an innovative range of interchangeable cabinet hardware that gives you more control over your design.



## MIX Straight Cabinet Knob

Code	Diameter (Dia)	Projection (P)	Base (B)
MIX2/KNOBONLY/32	32mm	29mm	10mm



## MIX Straight Cabinet Knob with Backplate

Code	Centres (C)	Diameter (Dia)	Projection (P)	Plate width (PW)	Plate length (PL)
MIX2/54	54mm	32mm	34mm	25mm	80mm
MIX2/128	128mm	32mm	34mm	25mm	154mm
MIX2/192	192mm	32mm	34mm	25mm	218mm

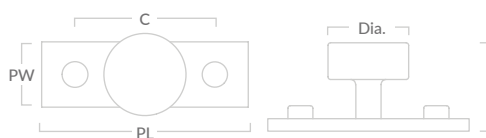

## MIX Straight Cabinet & Appliance Handle

Code	Centres (C)	Bar diameter	Projection (P)	Length (L)
MIX2/PULLONLY/128	128mm	11mm	34mm	170mm
MIX2/PULLONLY/160	160mm	11mm	34mm	202mm
MIX2/PULLONLY/224	224mm	14mm	37mm	274mm
MIX2/PULLONLY/288	288mm	14mm	37mm	338mm
MIX2/PULLONLY/APP/384	384mm	18mm	50mm	434mm
MIX2/PULLONLY/APP/608	608mm	18mm	50mm	658mm

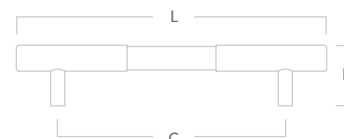

All products photographed in our aged brass (BEL) finish.

## MIX Straight Cabinet & Appliance Handle with Backplate

Code	Centres (C)	Bar diameter	Projection (P)	Plate length (PL)	Plate width (PW)
MIX2/PULL/128	128mm	11mm	39mm	198mm	25mm
MIX2/160	160mm	11mm	39mm	230mm	25mm
MIX2/224	224mm	14mm	42mm	310mm	32mm
MIX2/288	288mm	14mm	42mm	374mm	32mm
MIX2/APP/384	384mm	18mm	56mm	470mm	35mm
MIX2/APP/608	608mm	18mm	56mm	694mm	35mm



## MIX Straight T-bar

Code	Centres (C)	Bar diameter	Projection (P)	Plate length (PL)	Plate width (PW)
MIX2T/65	83mm	16mm	38mm	101mm	32mm

Not suitable for appliance doors



## MIX Straight Wall Hook Rack

Code	Centres (C1)	Centres (C2)	Bar diameter	Plate length (PL)	Projection (P)	Plate width (W)	Length (L)	Hooks
MIX2/HOOK/384	108mm	150mm	16mm	384mm	38mm	32mm	51mm	3
MIX2/HOOK/684	108mm	150mm	16mm	684mm	38mm	32mm	51mm	5

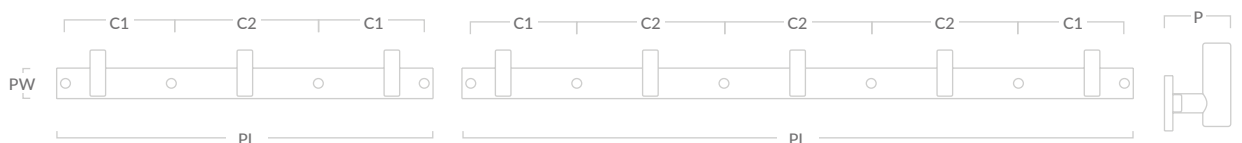

## MIX Straight Single Vertical Wall Hook

Code	Centres (C)	Bar diameter	Length (L)	Plate length (PL)	Projection (P)	Plate width (PW)
MIX2/V/HOOK/84	66mm	16mm	48mm	84mm	38mm	32mm

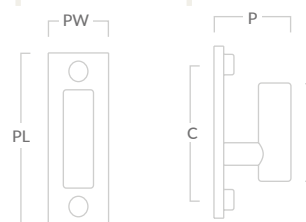

## MIX Straight Single Horizontal Wall Hook

Code	Centres (C)	Bar diameter	Length (L)	Plate length (PL)	Projection (P)	Plate width (PW)
MIX2/H/HOOK/84	66mm	16mm	48mm	84mm	38mm	32mm

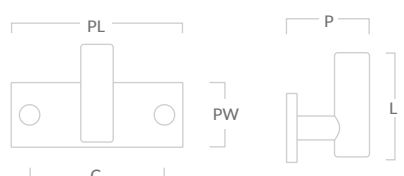

# MIX Plain collection

Contemporary

'Made by us. Mixed by you.'

The MIX collection is an innovative range of interchangeable cabinet hardware that gives you more control over your design.



## MIX Plain Cabinet Knob

Code	Diameter (Dia)	Projection (P)	Base (B)
MIX3/KNOBONLY/32	32mm	29mm	10mm



## MIX Plain Cabinet Knob with Backplate

Code	Centres (C)	Diameter (Dia)	Projection (P)	Plate width (PW)	Plate length (PL)
MIX3/54	54mm	32mm	34mm	25mm	80mm
MIX3/128	128mm	32mm	34mm	25mm	154mm
MIX3/192	192mm	32mm	34mm	25mm	218mm

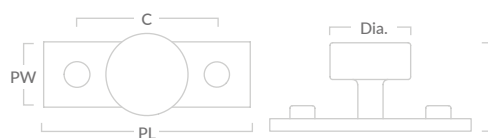

## MIX Plain Cabinet & Appliance Handle

Code	Centres (C)	Bar diameter	Projection (P)	Length (L)
MIX3/PULLONLY/128	128mm	11mm	34mm	170mm
MIX3/PULLONLY/160	160mm	11mm	34mm	202mm
MIX3/PULLONLY/224	224mm	14mm	37mm	274mm
MIX3/PULLONLY/288	288mm	14mm	37mm	338mm
MIX3/PULLONLY/APP/384	384mm	18mm	50mm	434mm
MIX3/PULLONLY/APP/608	608mm	18mm	50mm	658mm



In-situ photographed in our satin nickel plate (SNP) & aged brass (BEL) finish. Product photographed in our aged brass (BEL) finish.



## MIX Plain Cabinet & Appliance Handle with Backplate

Code	Centres (C)	Bar diameter	Projection (P)	Plate length (PL)	Plate width (PW)
MIX3/PULL/128	128mm	11mm	39mm	198mm	25mm
MIX3/160	160mm	11mm	39mm	230mm	25mm
MIX3/224	224mm	14mm	42mm	310mm	32mm
MIX3/288	288mm	14mm	42mm	374mm	32mm
MIX3/APP/384	384mm	18mm	56mm	470mm	35mm
MIX3/APP/608	608mm	18mm	56mm	694mm	35mm

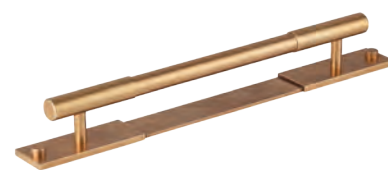

## MIX Plain T-bar

Code	Centres (C)	Bar diameter	Projection (P)	Plate length (PL)	Plate width (PW)
MIX3T/65	83mm	16mm	38mm	101mm	32mm

Not suitable for appliance doors



## MIX Plain Wall Hook Rack

Code	Centres (C1)	Centres (C2)	Bar diameter	Plate length (PL)	Projection (P)	Plate width (W)	Length (L)	Hooks
MIX3/HOOK/384	108mm	150mm	16mm	384mm	38mm	32mm	51mm	3
MIX3/HOOK/684	108mm	150mm	16mm	684mm	38mm	32mm	51mm	5

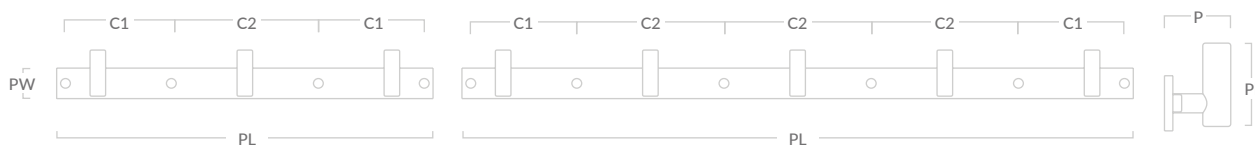

## MIX Plain Single Vertical Wall Hook

Code	Centres (C)	Bar diameter	Length (L)	Plate length (PL)	Projection (P)	Plate width (PW)
MIX3/V/HOOK/84	66mm	16mm	48mm	84mm	38mm	32mm

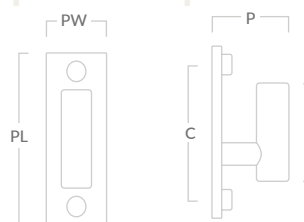

## MIX Plain Single Horizontal Wall Hook

Code	Centres (C)	Bar diameter	Length (L)	Plate length (PL)	Projection (P)	Plate width (PW)
MIX3/H/HOOK/84	66mm	16mm	48mm	84mm	38mm	32mm

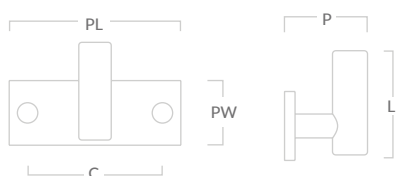

# Bromwich collection

Contemporary

Industrial in design, the Bromwich collection has a minimalistic edge to elevate modern spaces.



## Bromwich Flush Pull

Code	Width (W)	Height (H)
BRW/FLUSH/110	110mm	64mm

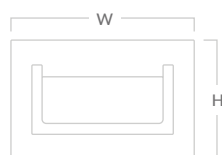

## Bromwich Cabinet Handle

Code	Plate length (PL)	Centres (C)	Projection (P)	Square bar
BRW/45	62mm	35.5mm	35mm	9.5mm
BRW/96	122mm	96mm	35mm	9.5mm
BRW/128	154mm	128mm	35mm	9.5mm
BRW/203	233mm	203mm	37mm	9.5mm
BRW/305	339mm	305mm	47mm	12.7mm



## Bromwich Appliance Handle

Code	Plate length (PL)	Centres (C)	Projection (P)	Square bar
BRW/APP/381	415mm	381mm	51mm	16mm
BRW/APP/608	642mm	608mm	51mm	16mm

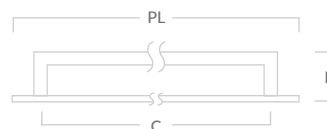

In-situ photographed in our satin antique satin lacquered (SAS) finish. Product photographed in our aged brass (BEL) finish.





# Victoria Stepped *collection*

Contemporary

Grand textures emulating opulent reeded glassware form the look of the Victoria Stepped collection.



## Victoria Stepped Cabinet Knob

Code	Diameter (D)	Projection (P)	Base (B)
VICK/25	25mm	28mm	25mm
VICK/32	32mm	32mm	32mm
VICK/38	38mm	35mm	38mm

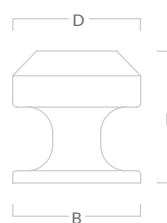

## Victoria Stepped Circular Pull Handle

Code	Diameter (D)	Projection (P)	Centres (C)	Base (B)
VIC/CIRCULARPULL/100	100mm	35mm	50mm	60mm



All products photographed in our satin antique satin lacquered (SAS) finish.

## Victoria Stepped Hook

Code	Diameter (D)	Projection (P)	Base (B)
VIC/HOOK/25	25mm	40mm	25mm

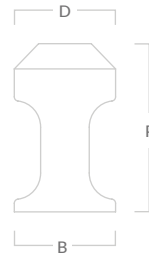

## Victoria Stepped Cup Pull Handle

Code	Width (W)	Height (H)	Centre (C)	Projection (P)
VIC/96	130mm	38mm	96mm	20mm
VIC/192	224mm	38mm	192mm	20mm
VIC/288	320mm	38mm	288mm	20mm
VIC/384	416mm	38mm	384mm	20mm

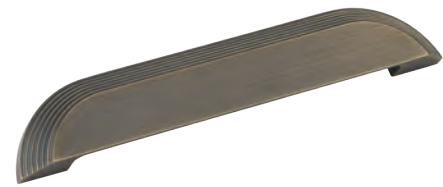
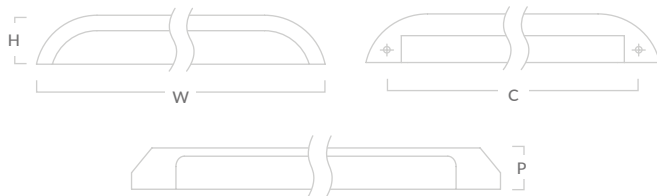

## Victoria Stepped Pull Handle

Code	Length (L)	Projection (P)	Centres (C)	Width (W)
VIC/PULL/96	115mm	45mm	96mm	33mm
VIC/PULL/128	147mm	45mm	128mm	33mm
VIC/PULL/160	179mm	45mm	160mm	33mm
VIC/PULL/224	243mm	45mm	224mm	33mm
VIC/PULL/288	307mm	45mm	288mm	33mm
VIC/APP/384	404mm	45mm	384mm	33mm
VIC/APP/608	626mm	45mm	608mm	33mm

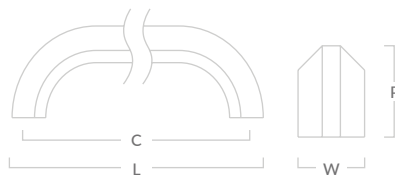

## Victoria Stepped D-Pull Handle

Code	Width (W)	Height (H)	Centre (C)	Projection (P)
VIC/DPULL/100	50mm	100mm	35mm	35mm
VIC/DPULL/150	75mm	150mm	64mm	35mm

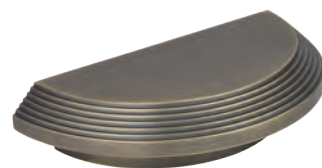
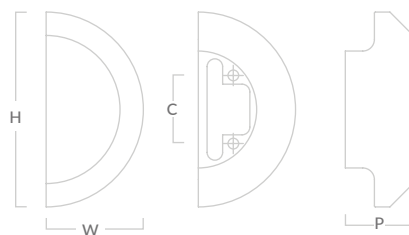

## Victoria Stepped C-Pull Handle

Code	Width (W)	Height (H)	Centre (C)	Projection (P)
VIC/CPULL/100	50mm	100mm	35mm	35mm
VIC/CPULL/150	75mm	150mm	64mm	35mm

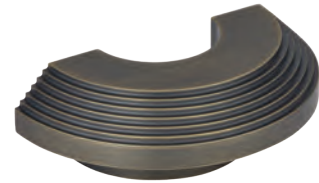
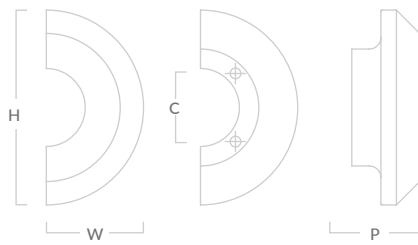

## Victoria Stepped Finger Cup Pull Handle

Code	Width (W)	Height (H)	Projection (P)
VIC/CUP/38/LH	47mm	38mm	20mm
VIC/CUP/38/RH	47mm	38mm	20mm

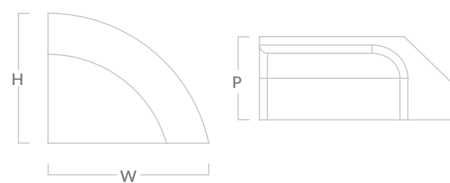



# Victoria Plain collection

Classic

Smooth surfaces and curved edges makes this expertly crafted luxury brass range an effortless piece for timeless interiors.



## Victoria Plain Cabinet Knob

Code	Diameter (D)	Projection (P)	Base (B)
VICK/PLAIN/25	25mm	28mm	25mm
VICK/PLAIN/32	32mm	32mm	32mm
VICK/PLAIN/38	38mm	35mm	38mm

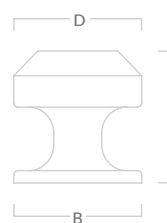

## Victoria Plain Circular Pull Handle

Code	Diameter (D)	Projection (P)	Centres (C)	Base (B)
VIC/PLAINCIRCULARPULL/100	100mm	35mm	50mm	60mm

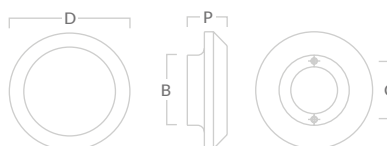

All products photographed in our aged brass (BEL) finish.

## Victoria Plain Hook

Code	Diameter (D)	Projection (P)	Base (B)
VIC/HOOK/PLAIN/25	25mm	40mm	25mm

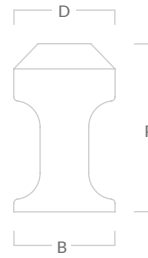

## Victoria Plain Cup Pull Handle

Code	Length (L)	Height (H)	Centre (HC)	Projection (P)
VIC/PLAIN/96	130mm	38mm	96mm	20mm
VIC/PLAIN/192	224mm	38mm	192mm	20mm
VIC/PLAIN/288	320mm	38mm	288mm	20mm
VIC/PLAIN/384	416mm	38mm	384mm	20mm

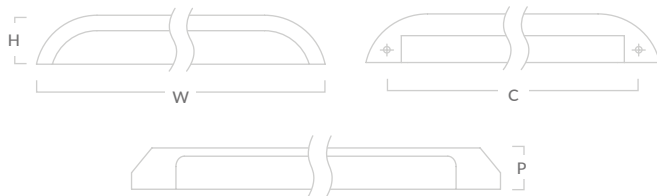

## Victoria Plain Pull Handle

Code	Length (L)	Projection (P)	Centres (C)	Width (W)
VIC/PULL/PLAIN/96	115mm	45mm	96mm	33mm
VIC/PULL/PLAIN/128	147mm	45mm	128mm	33mm
VIC/PULL/PLAIN/160	179mm	45mm	160mm	33mm
VIC/PULL/PLAIN/224	243mm	45mm	224mm	33mm
VIC/PULL/PLAIN/288	307mm	45mm	288mm	33mm
VIC/APP/PLAIN/384	404mm	45mm	384mm	33mm
VIC/APP/PLAIN/608	626mm	45mm	608mm	33mm

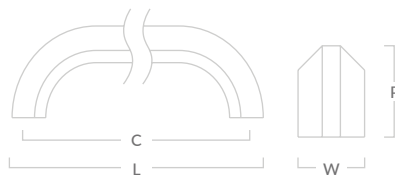

## Victoria Plain D-Pull Handle

Code	Width (W)	Height (H)	Hole centre (HC)	X	Projection (P)	Underside (U)	Underside length (UL)
VIC/DPULL/PLAIN/100	50mm	100mm	35mm	18mm	35mm	15mm	60mm
VIC/DPULL/PLAIN/150	75mm	150mm	64mm	32mm	35mm	15mm	110mm

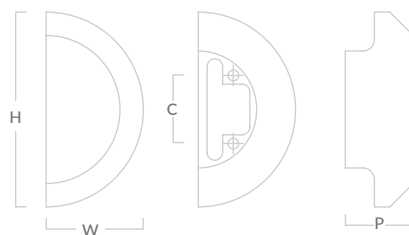

## Victoria Plain C-Pull Handle

Code	Width (W)	Height (H)	Centre (C)	Projection (P)
VIC/CPULL/PLAIN/100	50mm	100mm	35mm	35mm
VIC/CPULL/PLAIN/150	75mm	150mm	64mm	35mm

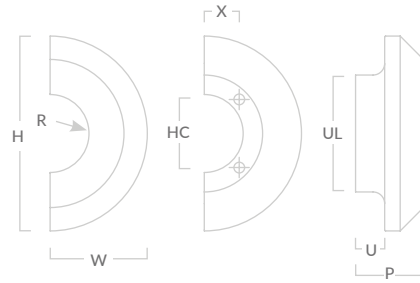

## Victoria Plain Finger Cup Pull Handle

Code	Width (W)	Height (H)	Projection (P)
VIC/CUP/PLAIN/38/LH	47mm	38mm	20mm
VIC/CUP/PLAIN/38/RH	47mm	38mm	20mm

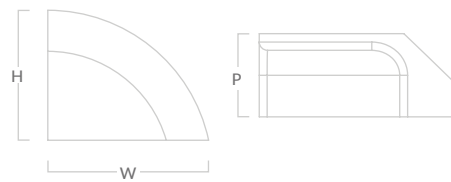

# Oblique *collection*

Classic

The juxtaposition of a square centre and circular rings in the Oblique collection create a subtle optical illusion.



## Oblique Cabinet Ring Pull

Code	Diameter (D)	Projection (P)	Height (H)
OBL/50	50mm	19mm	51mm
OBL/64	64mm	21mm	65mm
OBL/82	82mm	25mm	86mm

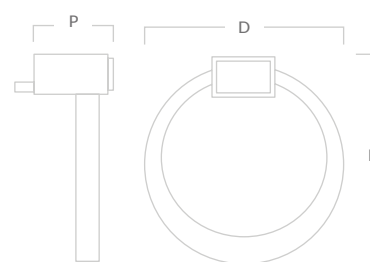

In-situ photographed in our aged brass (BEL) finish. Product photographed in our satin antique satin lacquered (SAS) finish.



# Quadrille collection

Classic

Bold squares form the design of the Quadrille collection for a statement look.



## Quadrille Cabinet Ring Pull

Code	Diameter (D)	Projection (P)	Height (H)
QUA/50	50mm	19mm	53mm
QUA/64	64mm	21mm	67mm
QUA/76	76mm	25mm	80mm

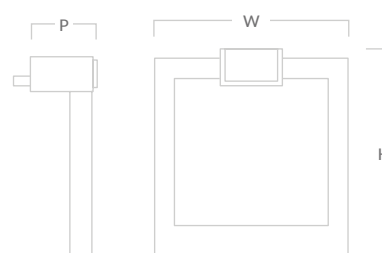

In-situ photographed in our satin nickel plate (SNP) finish. Product photographed in satin antique satin lacquered (SAS) finish.

# Dougan collection

Classic

Presenting a beautiful blend of style and sophistication, the Dougan collection draws inspiration from the deco design era.



## Dougan Cabinet Knob

Code	Diameter (D)	Projection (P)	Base (B)
DOUK/25	25mm	23mm	19mm
DOUK/32	32mm	29mm	24mm
DOUK/38	38mm	34mm	28mm

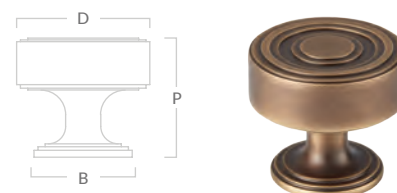

## Dougan Cabinet & Appliance Handle

Code	Length (L)	Centres (C)	Projection (P)	Bar width
DOU/PULLONLY/96	107mm	96mm	33mm	16 x 11mm
DOU/PULLONLY/160	171mm	160mm	33mm	16 x 11mm
DOU/PULLONLY/224	235mm	224mm	33mm	16 x 11mm
DOU/PULLONLY/APP/320	333mm	320mm	45mm	18 x 13mm
DOU/PULLONLY/APP/608	621mm	608mm	45mm	18 x 13mm

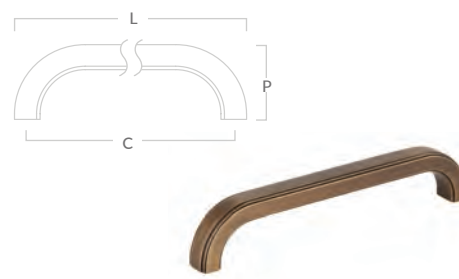

## Dougan Cabinet & Appliance Handle with Backplate

Code	Plate width (PW)	Centres (C)	Projection (P)	Base width	Bar width
DOU/96	123mm	96mm	38mm	32mm	16 x 11mm
DOU/160	187mm	160mm	38mm	32mm	16 x 11mm
DOU/224	251mm	224mm	38mm	32mm	16 x 11mm
DOU/APP/320	352mm	320mm	49mm	38mm	18 x 13mm
DOU/APP/608	640mm	608mm	49mm	38mm	18 x 13mm

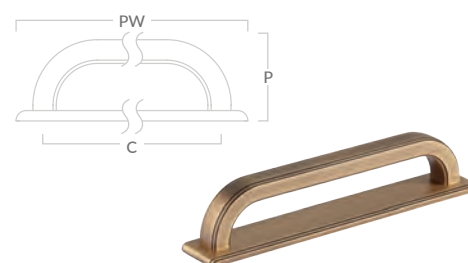

All products photographed in our satin antique satin lacquered (SAS) finish.



In-situ photographed in our aged brass (BEL) finish.



# Grove collection

Classic

Inspired by one of nature's most iconic forms, discover the charm of bamboo with the Grove collection, designed in collaboration with Sophie Paterson.



## Grove Hook

Code	Projection (P)	Diameter (D)
GRVTK/19	34mm	19mm
GRV/HOOK/34	34mm	19mm



## Grove Thumb Knob

Code	Projection (P)	Diameter (D)
GRVTK/19	34mm	19mm
GRV/HOOK/34	34mm	19mm



All products photographed in our satin antique satin lacquered (SAS) finish.



## Grove Cabinet Knob

Code	Projection (P)	Base (B)	Diameter (D)
GRVK/25	25mm	15mm	25mm
GRVK/32	31mm	17mm	32mm
GRVK/38	37mm	19mm	38mm

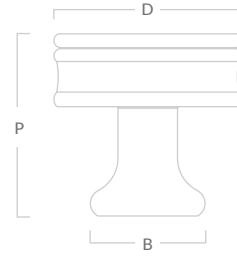

## Grove T-bar Cabinet Handle

Code	Width (W)	Projection (P)	Base (B)
GRVT/64	64mm	43mm	17mm

Not suitable for appliance doors

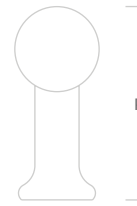
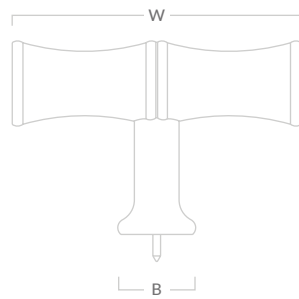

## Grove Cabinet Handle & Appliance Handle

Code	Length (L)	Projection (P)	Base (B)	Centres (C)	Bar diameter
GRV/96	148mm	43mm	17mm	96mm	19mm
GRV/128	180mm	43mm	17mm	128mm	19mm
GRV/160	212mm	43mm	17mm	160mm	19mm
GRV/224	276mm	43mm	17mm	224mm	19mm
GRV/228	340mm	43mm	17mm	288mm	19mm
GRV/APP/384	436mm	51mm	20mm	384mm	22mm
GRV/APP/608	660mm	51mm	20mm	608mm	22mm

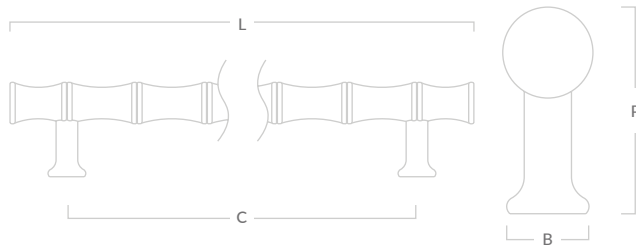

# Harold collection

Classic

Created to celebrate 90 years of Armac Martin, the Harold collection takes inspiration from our treasured heritage and one of our original founders. Also available in a plain design.



## Harold Hammered Cabinet Knob

Code	Width (W)	Projection (P)	Base (B)
HRLK/32	32mm	29mm	20mm

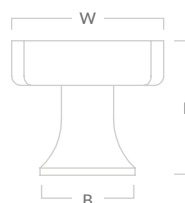

## Harold Hammered T-bar Handle

Code	Width (W)	Projection (P)	Base (B)
HRLT/58	58mm	29mm	20mm

Not suitable for appliance doors

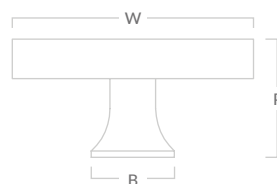

## Harold Hammered Cabinet & Appliance Handle

Code	Length (L)	Centres (C)	Projection (P)	Bar width
HRL/96	116mm	96mm	29mm	20 x 9.5mm
HRL/160	184mm	160mm	31mm	23 x 9.5mm
HRL/224	248mm	224mm	31mm	25 x 9.5mm
HRL/APP/352	382mm	352mm	41mm	28 x 12.7mm

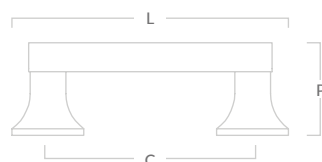

In-situ photographed in our aged brass (BEL) finish. Product photographed in satin antique satin lacquered (SAS) finish.

### Harold Plain Cabinet Knob

Code	Width (W)	Projection (P)	Base (B)
HRLK/PLAIN/32	32mm	29mm	20mm

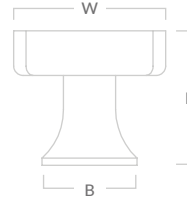

### Harold Plain T-bar Handle

Code	Width (W)	Projection (P)	Base (B)
HRLK/PLAIN/58	58mm	29mm	20mm

Not suitable for appliance doors

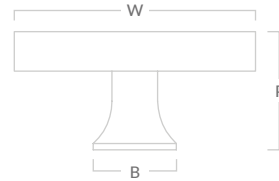

### Harold Plain Cabinet & Appliance Handle

Code	Length (L)	Centres (C)	Projection (P)	Bar width
HRL/PLAIN/96	116mm	96mm	29mm	20 x 9.5mm
HRL/PLAIN/160	184mm	160mm	31mm	23 x 9.5mm
HRL/PLAIN/224	248mm	224mm	31mm	25 x 9.5mm
HRL/PLAIN/APP/352	382mm	352mm	41mm	28 x 12.7mm

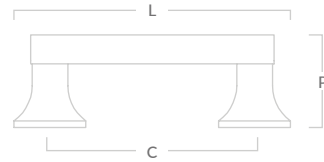

Product photographed in our aged brass (BEL) finish.

# Flush pulls

Classic

Bring understated style and subtle interest to cabinetry with our collection of rear-fixed solid brass flush pulls.



## Lyndon Flush Pull

Code	Width (W)	Projection (P)	Height (H)	Centres (C)	X	Y
LYN/FLUSH/100	100mm	18mm	57mm	88mm	81mm	32mm
LYN/FLUSH/175	175mm	18mm	57mm	163mm	156mm	32mm
LYN/FLUSH/250	250mm	18mm	57mm	238mm	231mm	32mm
LYN/FLUSH/350	350mm	18mm	57mm	338mm	331mm	32mm

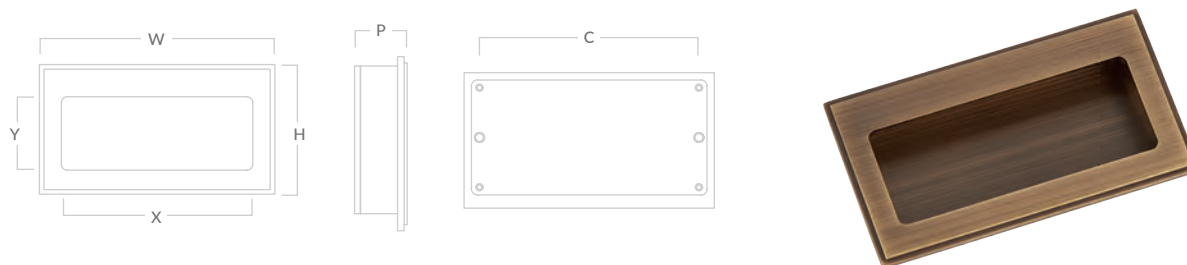

All products photographed in our satin antique satin lacquered (SAS), aged brass (BEL) & polished brass unlacquered (PBUL) finish.



## Driffold Flush Pull

Code	Width (W)	Projection (P)	Height (H)	Centres (C)	X	Y
DRI/FLUSH/100	100mm	18mm	57mm	88mm	81mm	32mm
DRI/FLUSH/175	175mm	18mm	57mm	163mm	156mm	32mm
DRI/FLUSH/250	250mm	18mm	57mm	238mm	231mm	32mm
DRI/FLUSH/350	350mm	18mm	57mm	338mm	331mm	32mm

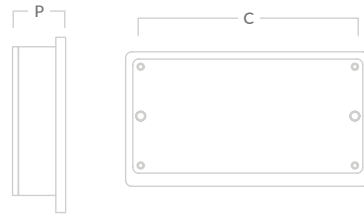
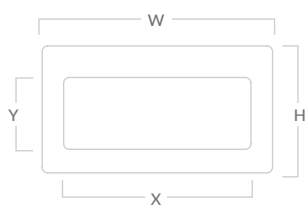

## Bartley Flush Pull

Code	Width (W)	Projection (P)	Height (H)	Centres (C)	X	Y
BAR/FLUSH/100	100mm	18mm	57mm	88mm	81mm	32mm
BAR/FLUSH/175	175mm	18mm	57mm	163mm	156mm	32mm
BAR/FLUSH/250	250mm	18mm	57mm	238mm	231mm	32mm
BAR/FLUSH/350	350mm	18mm	57mm	338mm	331mm	32mm

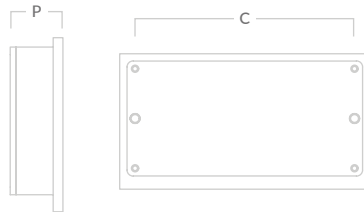





## Decorative *grilles*

Our collection of luxury brass decorative grilles add visual interest to cabinetry and elegantly conceal radiators, fuse boxes, panels and vents.

From regency-inspired designs to deco styles, our solid brass grilles feature beautiful symmetry and add luxurious texture to interiors.

Made to order and assembled by hand, each of our decorative grilles is crafted with precision and is available in a selection of brass finishes.

# Grille finishes

To complement your design scheme, choose from a hand-picked selection of our most-coveted brass finishes and transform the appearance of your decorative grilles.

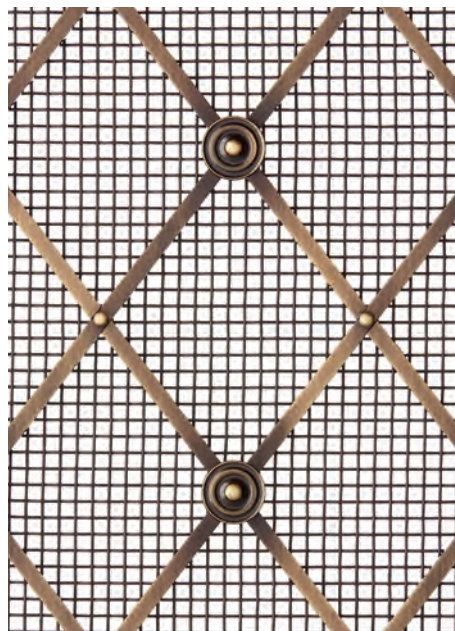

**ABL - Antique brass lacquered**

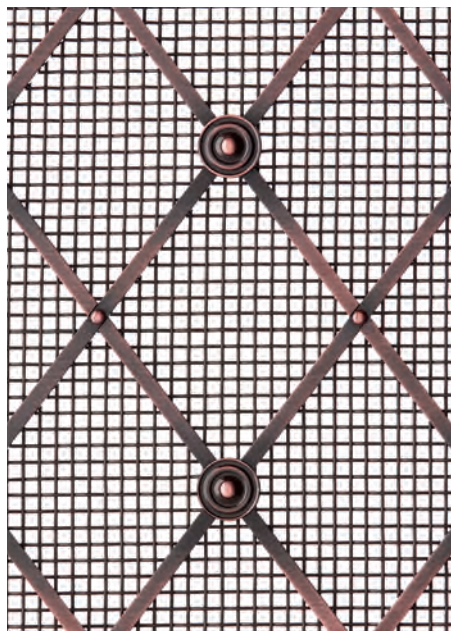

**ACL - Antique copper lacquered**

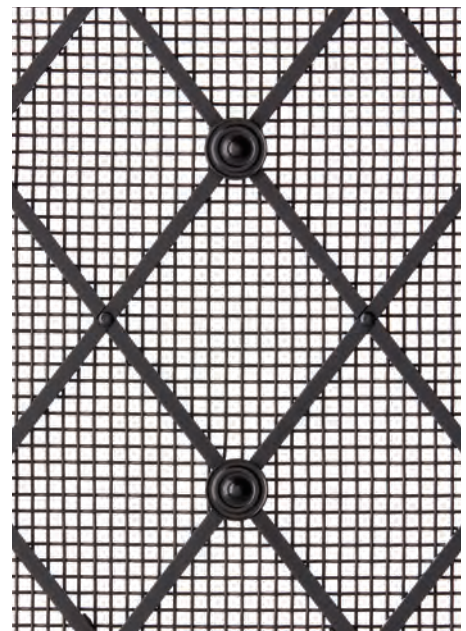

**BMA - Bronze metal antique**

In-situ grille photographed in our antique brass lacquered (ABL) finish.



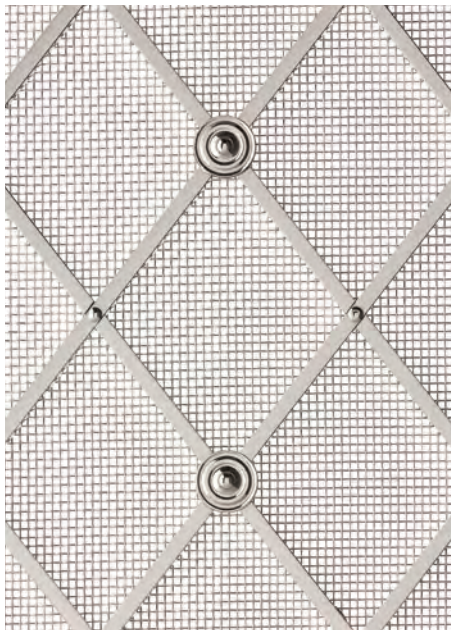

**PCP - Polished chrome plate**

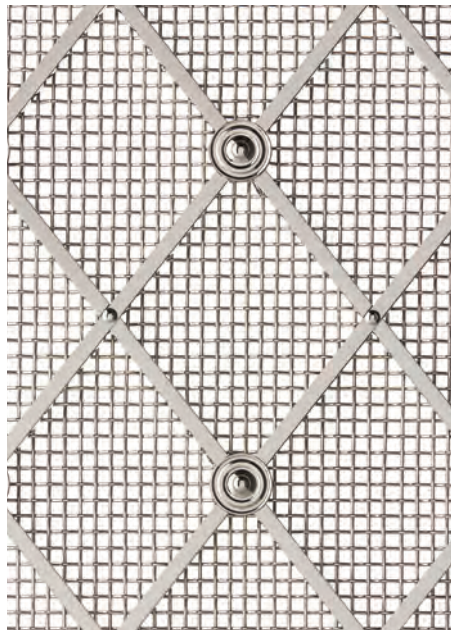

**PNP - Polished nickel plate**

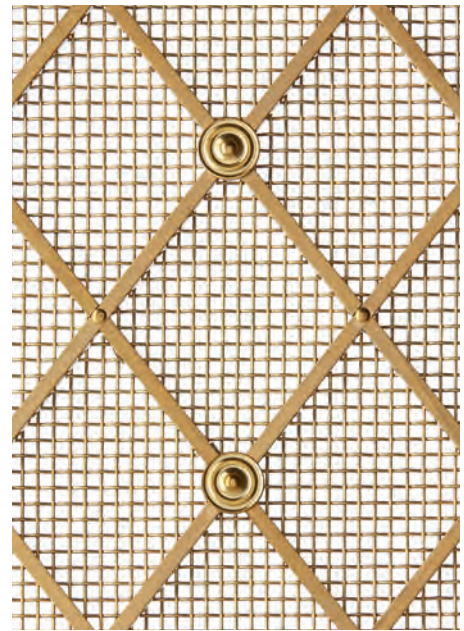

**SBL - Satin brass lacquered**

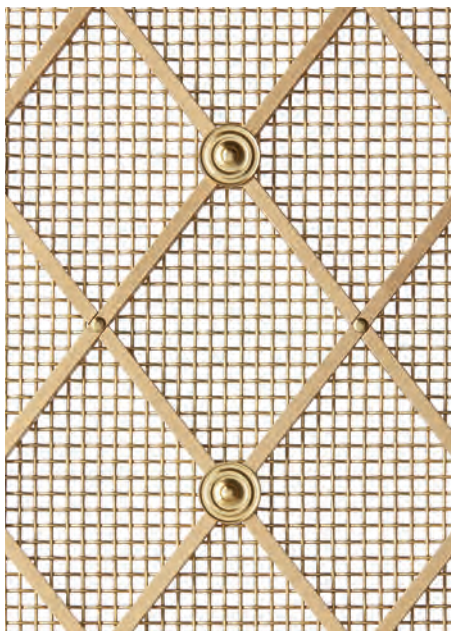

**SBUL - Satin brass unlacquered**



**SCP - Satin chrome plate**

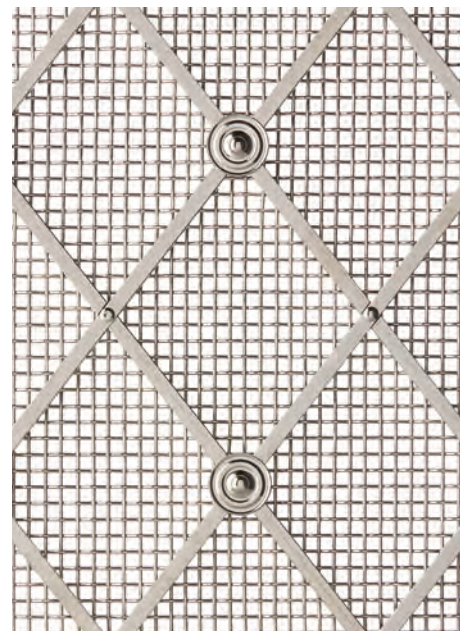

**SNP - Satin nickel plate**

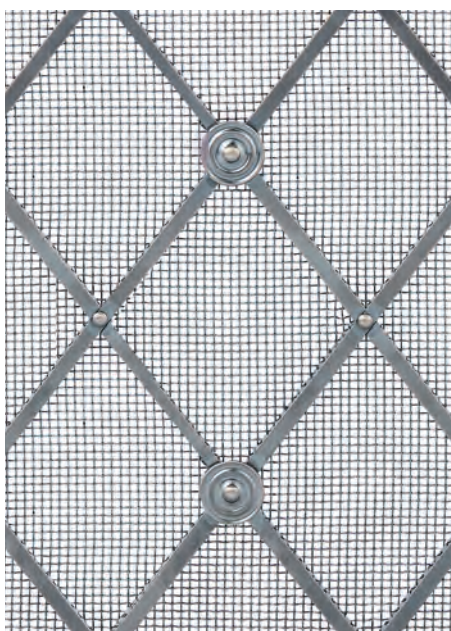

**ASL - Antique silver lacquered**



**Hand-finished by**

our team of expert craftsmen in the heart of Birmingham.



# Regency Diamond *grilles*

Handcrafted in solid brass, our Regency Diamond grilles add an elegant touch to interiors. Featuring a perfectly symmetrical pattern assembled by hand and trimmed to fit your required aperture, your grille will come ready to fit.



## Diamond options

Available in three different diamond sizes, each made from a 3.2mm square section brass bar and fitted to hold with decorative pins.

Width (W)	Height (H)	Internal diagonal dia (Dia.)
33mm (1¼")	44mm (1⅞")	25mm (1")
51mm (2")	64mm (2½")	38mm (1½")
70mm (2¾")	89mm (3½")	54mm (2⅛")

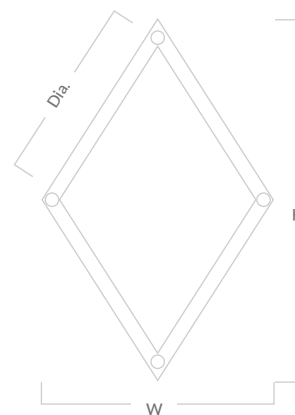

In-situ grille photographed in our antique brass lacquered (ABL) finish.

## Rosette options

Available with the option of plain or floral rosettes on every or alternating crossovers. They can also be supplied without rosettes, showing the pinheads only. An additional option of a mixed finish is available on request for some grilles.



Plain

Floral

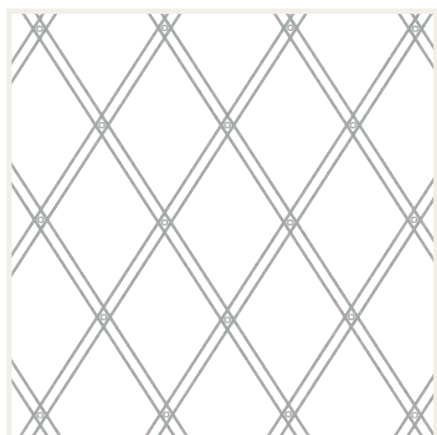

No rosette

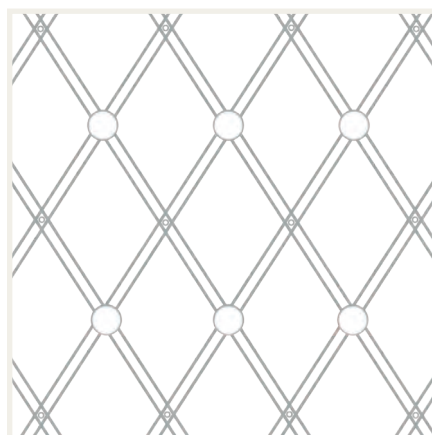

Alternating rosettes

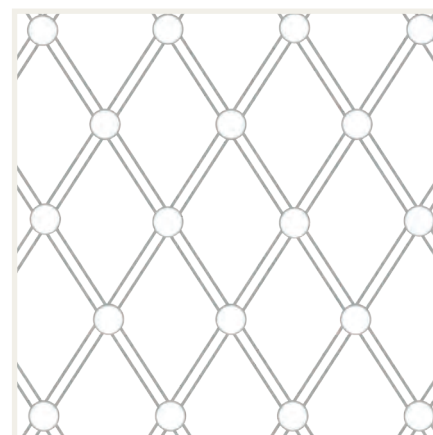

All rosettes

## Mesh options

Available with a number of mesh options, for more information, please see [page 121](#).

## Grille frame

Available with a metal frame, for more information please see [page 120](#).

## Mixed finish

- Grilles without rosettes can only be satin brass and satin brass lacquered but with a backing mesh in any other finish
- Grilles with alternate rosettes can be mixed with two finishes (excluding BMA). The grille is one finish and the mesh and rosettes a different finish
- Grilles with rosettes on all joins cannot be offered in a mixed finish

## Cut pins

(The pins used to assemble the grilles are clipped at the back and hammered over to create a cleaner look)

- They are only offered when grilles have no mesh backing
- They cannot be offered on grilles with polished nickel, polished chrome or bronze metal antique

## Grille tolerance

All grilles are made to a 3.175mm ( $\frac{1}{8}$ " ) tolerance.

## Finish options

To see our 10 grille finishes in full, please turn to [page 100](#).

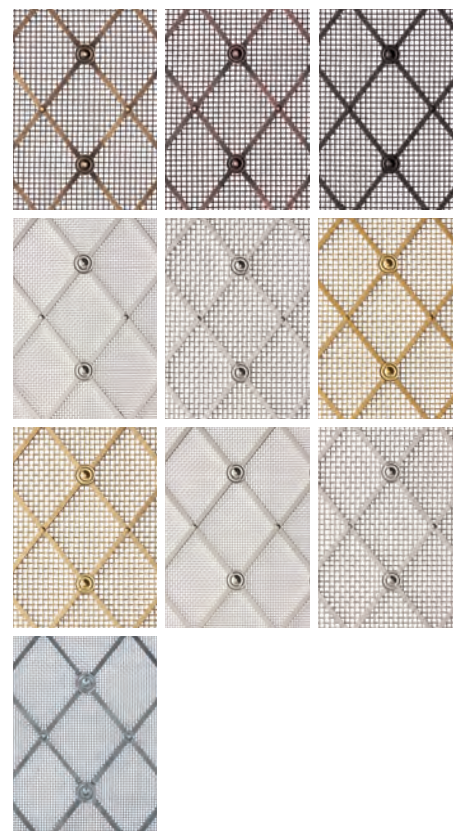

## Ordering your grille

Please turn to [page 122](#) for details on how to order your grille.



## Elliptical *grilles*

Our Elliptical Pattern grilles add a truly sophisticated look to cabinet doors, radiator covers and more. Handcrafted from solid brass and made to fit into your required aperture, they come ready to install.

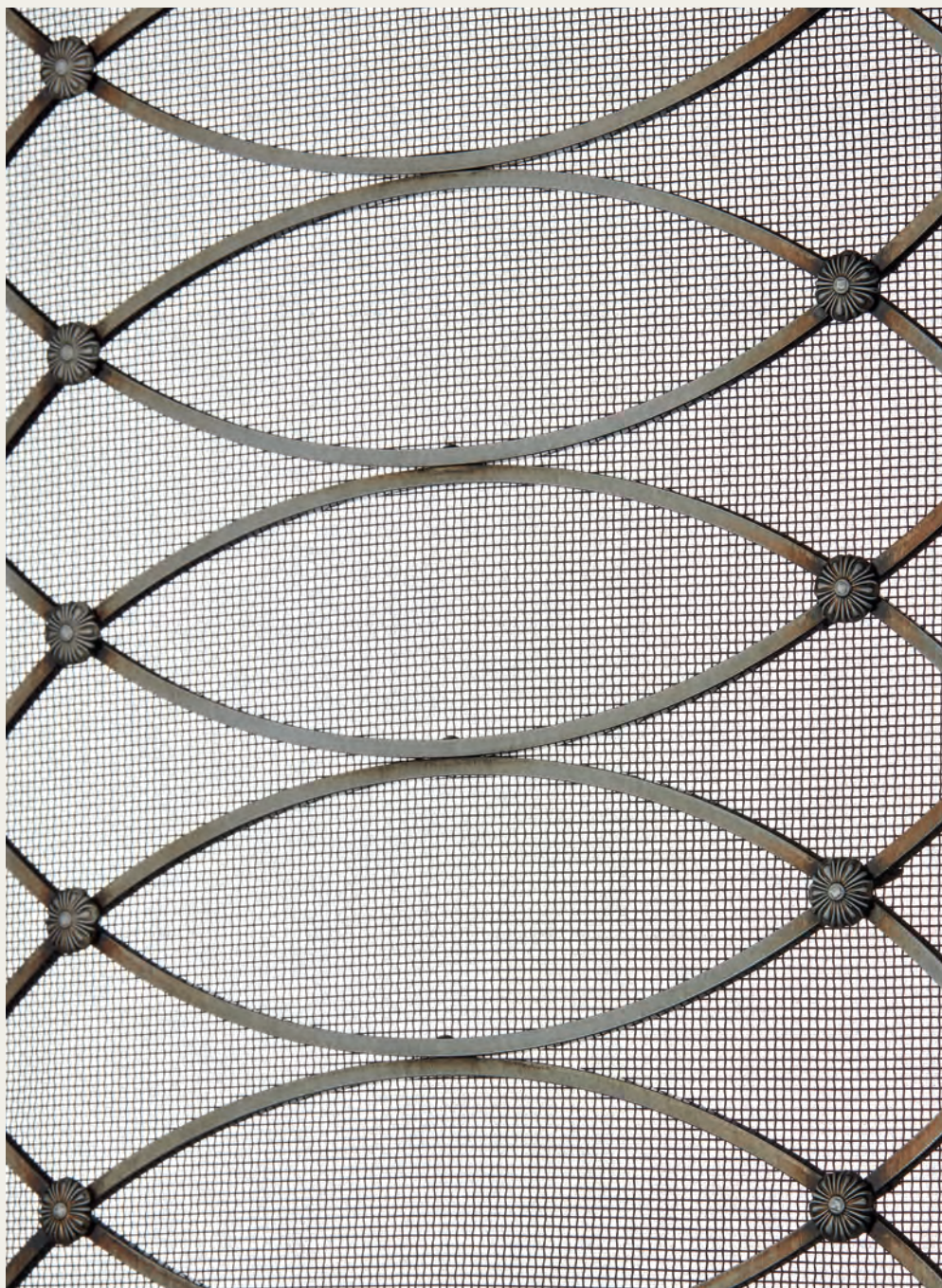

### Orientation options

The ellipses will stretch to match either the height or width of your required measurements as indicated by the orientation on the right.

Please note, the longer measurement of your required panel needs to run in alignment with the stacked ellipses to achieve the desired look. For example, the height of the vertical grilles should be longer than the width.

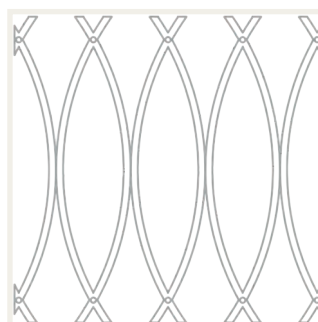
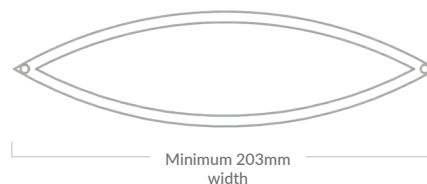

Horizontal

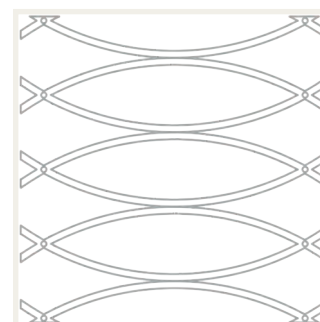

Vertical

In-situ grille photographed in our antique brass lacquered (ABL) finish.



## Rosette options

Available with the option of plain or floral rosettes on every or alternating crossovers. They can also be supplied without rosettes, showing the pinheads only. An additional option of a mixed finish is available on request for some grilles.



Plain

Floral

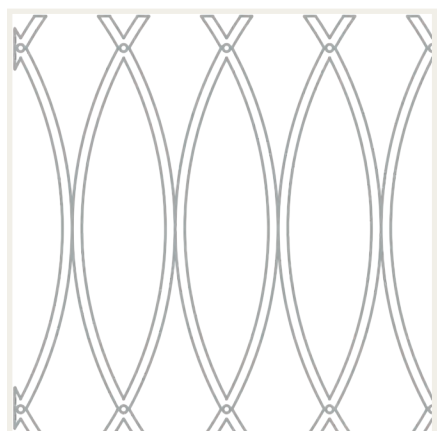

No rosette

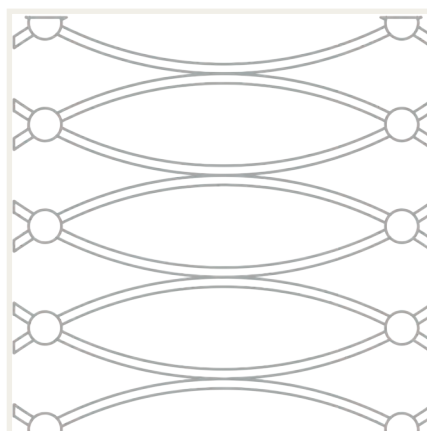

All rosettes

## Mesh options

Available with a number of mesh options, for more information, please see [page 121](#).

## Grille frame

Available with a metal frame, for more information please see [page 120](#).

## Grille tolerance

All grilles are made to a 3.175mm ( $\frac{1}{8}$ " ) tolerance.

## Finish options

To see our 10 grille finishes in full, please turn to [page 100](#).



## Ordering your grille

Please turn to [page 122](#) for details on how to order your grille.

# Georgian Square *grilles*

Our Georgian Square grilles add a touch of finesse to panels, doors, vents and more. Hand crafted from solid brass and made to fit into your required aperture, they come ready to install.



## Square options

Available in three different square sizes, each made from a 3.2mm square section brass bar and fitted to hold with decorative pins.

### Dimensions (Dim)

25mm (1")

38mm (1½")

54mm (2 ¼")

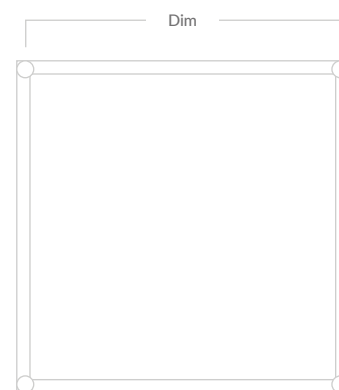

In-situ grille photographed in our antique brass lacquered (ABL) finish.

## Rosette options

Available with the option of plain or floral rosettes on every crossover. They can also be supplied without rosettes, showing the pinheads only. An additional option of a mixed finish is available on request for some grilles.



Plain

Floral

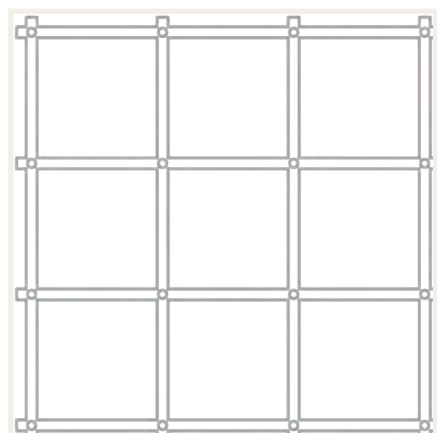

No rosette

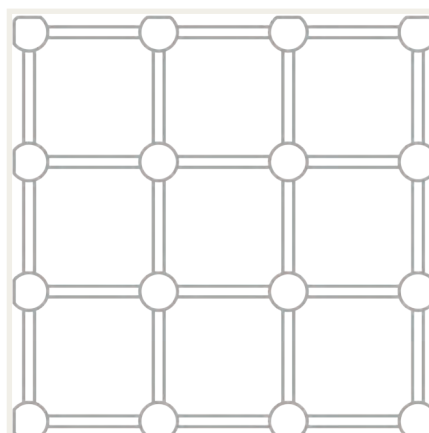

All rosettes

## Mesh options

Available with a number of mesh options, for more information, please see [page 121](#).

## Grille frame

Available with a metal frame, for more information please see [page 120](#).

## Grille tolerance

All grilles are made to a 3.175mm ( $\frac{1}{8}$ " ) tolerance.

## Finish options

To see our 10 grille finishes in full, please turn to [page 100](#).

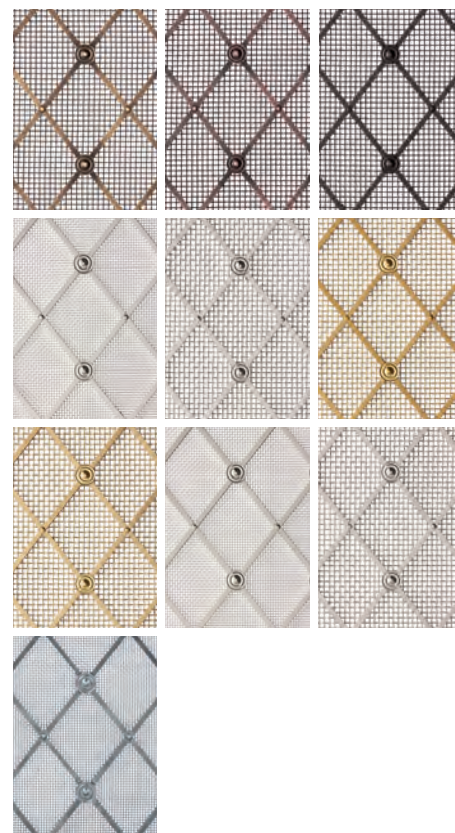

## Ordering your grille

Please turn to [page 122](#) for details on how to order your grille.



# Diamond Interwoven *grilles*

A basket weave style, our hand-woven Diamond Interwoven grille is available in a number of different apertures and section size configurations and is supplied in a diamond layout with either plain or reeded style sections.



## Diamond options

Available in four different diamond sizes.

### Dimensions (Dim)

10mm (3/8")

13mm (1/2")

19mm (3/4")

25mm (1")

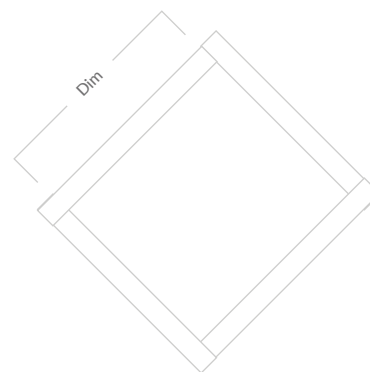

In-situ grille photographed in our antique brass lacquered (ABL) finish.

## Plain or reeded wire

Interwoven grilles are available in both plain and reeded wires with an option of 3mm and 5mm wire width.

3mm wire is not available with 25mm diamond sizes.



Plain wire

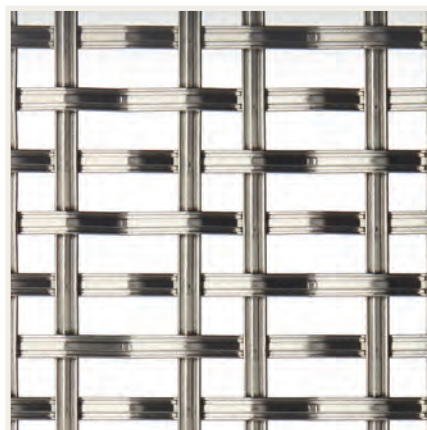

Reeded wire

## Mesh options

Available with a number of mesh options, for more information, please see [page 121](#).

## Grille frame

Available with a metal frame, for more information, please see [page 120](#).

## Grille tolerance

All grilles are made to a 3.175mm ( $\frac{1}{8}$ " ) tolerance.

## Finish options

To see our 10 grille finishes in full, please turn to [page 100](#).



## Ordering your grille

Please turn to [page 122](#) for details on how to order your grille.



# Square Interwoven *grilles*

A basket weave style, our hand-woven Square Interwoven grille is available in a number of different apertures and section size configurations and is supplied in a square layout with either plain or reeded style sections.



## Square options

Available in four different square sizes.

### Dimensions (Dim)

10mm (3/8")

13mm (1/2")

19mm (3/4")

25mm (1")



In-situ grille photographed in our polished nickel plate (PNP) finish.



## Plain or reeded wire

Interwoven grilles are available in both plain and reeded wires with an option of 3mm and 5mm wire width.

3mm wire is not available with 25mm diamond sizes.



Plain wire

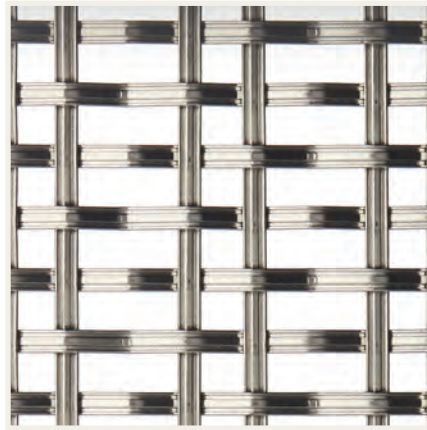

Reeded wire

## Mesh options

Available with a number of mesh options, for more information, please see [page 121](#).

## Grille frame

Available with a metal frame, for more information, please see [page 120](#).

## Grille tolerance

All grilles are made to a 3.175mm ( $\frac{1}{8}$ " ) tolerance.

## Finish options

To see our 10 grille finishes in full, please turn to [page 100](#).

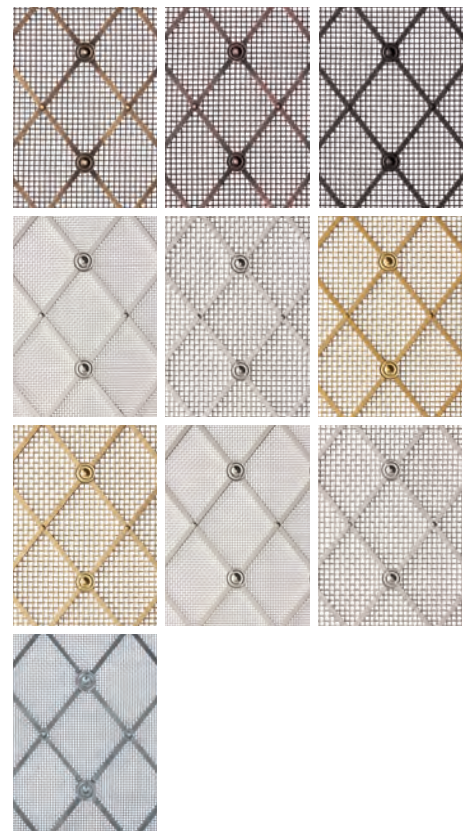

## Ordering your grille

Please turn to [page 122](#) for details on how to order your grille.

# Double Square Interwoven grilles

A basket weave style, our hand-woven Double Square Interwoven grille is available in a number of different apertures and section size configurations and is supplied in a square layout with either plain or reeded style sections.

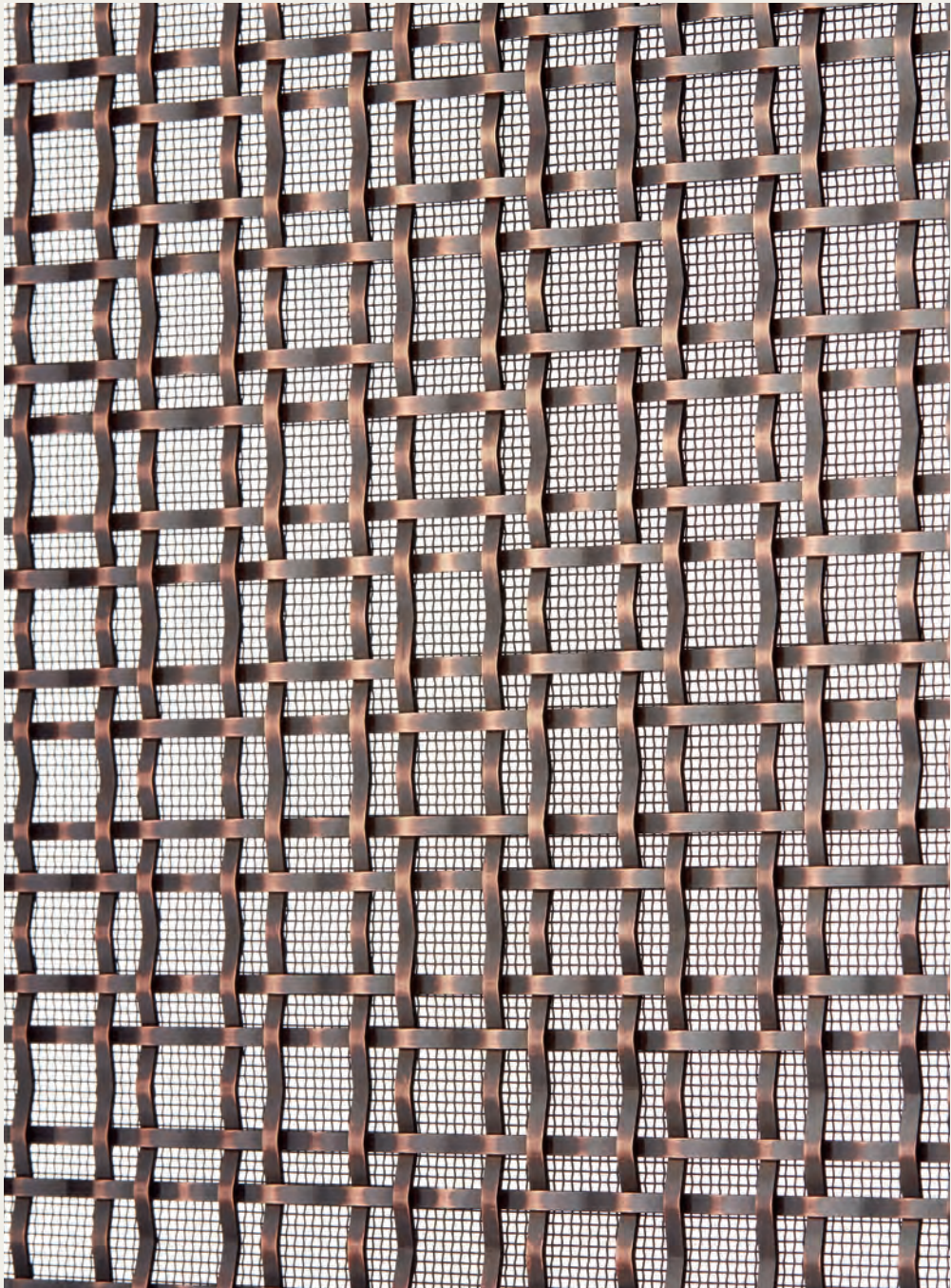

## Square options

Available in three different square sizes.

Dimensions (Dim)
13mm (½")
19mm (¾")
25mm (1")

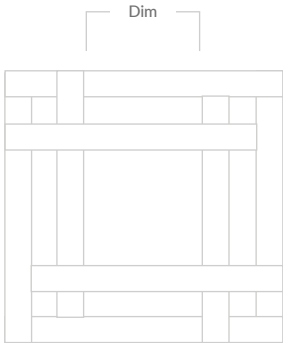

In-situ grille photographed in our antique brass lacquered (ABL) finish.



## Plain or reeded wire

Double interwoven grilles are available in both plain and reeded wires with a 3mm wire width.



Plain wire

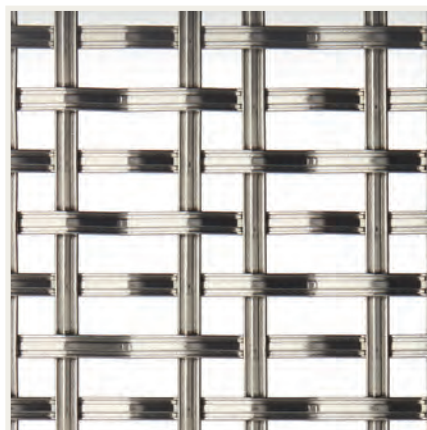

Reeded wire

## Mesh options

Available with a number of mesh options, for more information, please see [page 121](#).

## Grille frame

Available with a metal frame, for more information, please see [page 120](#).

## Grille tolerance

All grilles are made to a 3.175mm ( $\frac{1}{8}$ " ) tolerance.

## Finish options

To see our 10 grille finishes in full, please turn to [page 100](#).



## Ordering your grille

Please turn to [page 122](#) for details on how to order your grille.



# Double Diamond Interwoven *grilles*

A basket weave style, our hand-woven Double Diamond Interwoven grille is available in a number of different apertures and section size configurations and is supplied in a diamond layout with either plain or reeded style sections.



## Diamond options

Available in three different diamond sizes.

Dimensions (Dim)
13mm (1/2")
19mm (3/4")
25mm (1")

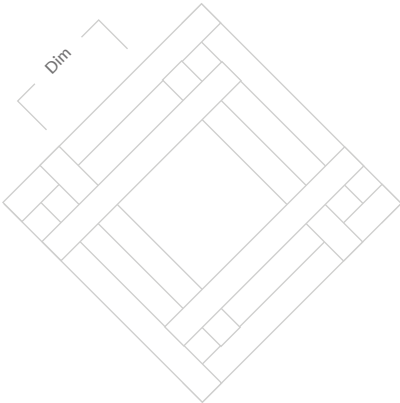

In-situ grille photographed in our satin brass unlacquered (SBUL) finish.

## Plain or reeded wire

Double Interwoven grilles are available in both plain and reeded wires with a 3mm wire width.



Plain wire

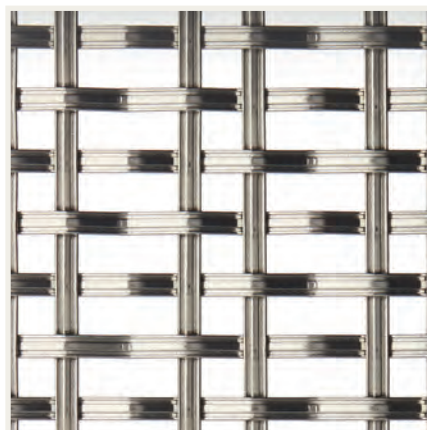

Reeded wire

## Mesh options

Available with a number of mesh options, for more information, please see [page 121](#).

## Grille frame

Available with a metal frame, for more information, please see [page 120](#).

## Grille tolerance

All grilles are made to a 3.175mm ( $\frac{1}{8}$ " ) tolerance.

## Finish options

To see our 10 grille finishes in full, please turn to [page 100](#).



## Ordering your grille

Please turn to [page 122](#) for details on how to order your grille.



# Double Rectangular Interwoven grilles

A basket weave style, our hand-woven Double Rectangular Interwoven grille is available in two orientations and is supplied in a rectangular layout with either reeded or plain style sections.



## Orientation options

Available in a horizontal or vertical style.

### Dimensions

13x3mm (½" x ¼")

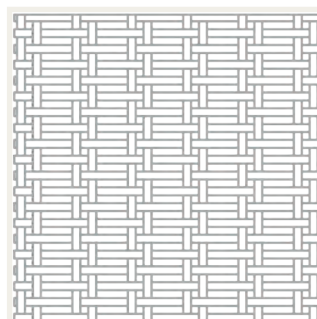

Horizontal

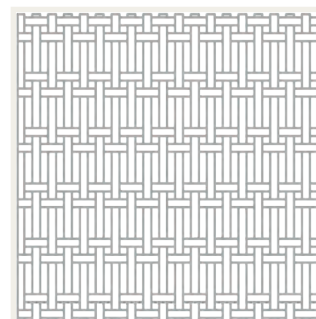

Vertical

In-situ grille photographed in our satin brass unlacquered (SBUL) finish.



## Plain or reeded wire

Double interwoven grilles are available in both plain and reeded wires with a 3mm wire width.



Plain wire

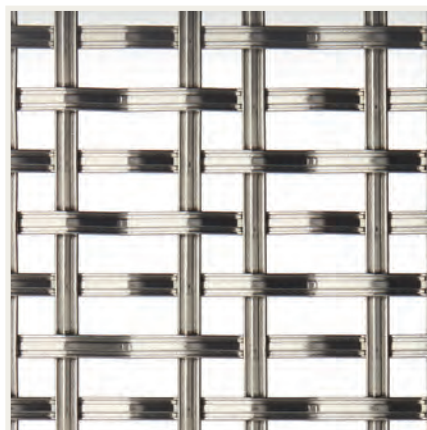

Reeded wire

## Mesh options

Available with a number of mesh options, for more information, please see [page 121](#).

## Grille frame

Available with a metal frame, for more information, please see [page 120](#).

## Grille tolerance

All grilles are made to a 3.175mm ( $\frac{1}{8}$ " ) tolerance.

## Finish options

To see our 10 grille finishes in full, please turn to [page 100](#).



## Ordering your grille

Please turn to [page 122](#) for details on how to order your grille.

## Perforated *sheet grilles*

Our decorative perforated sheet grilles are used in kitchens as radiator covers or on interior doors.

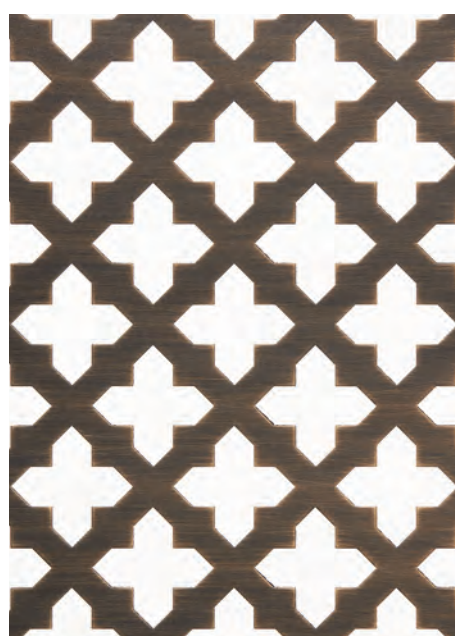

**Large cross**  
23mm point to point



**Interlocking circle**  
34.9mm circle diameter

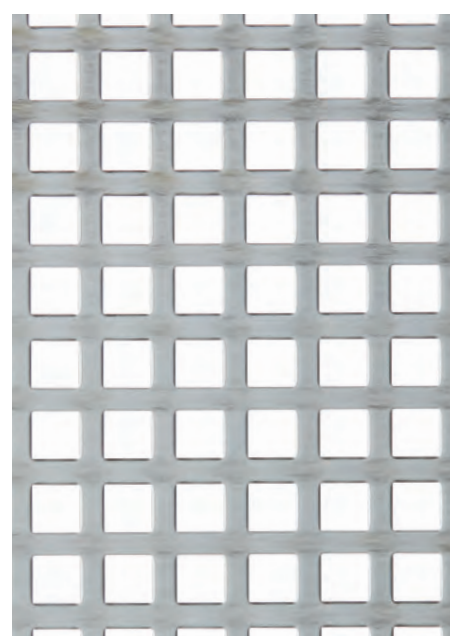

**Square**  
6.3mm internal square

In-situ grille photographed in our satin brass lacquered (SBL) finish.



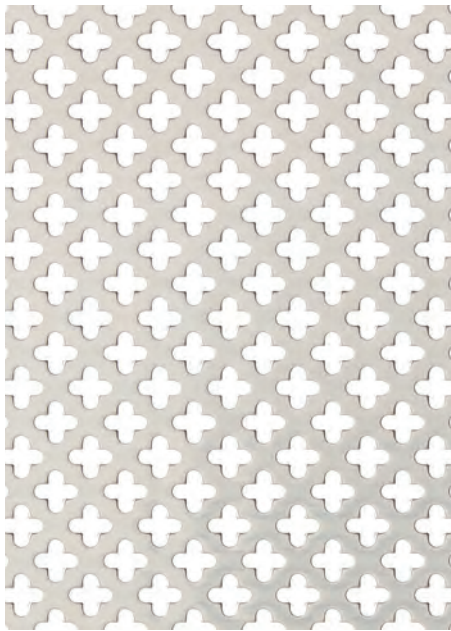

**Small club**  
6mm max width

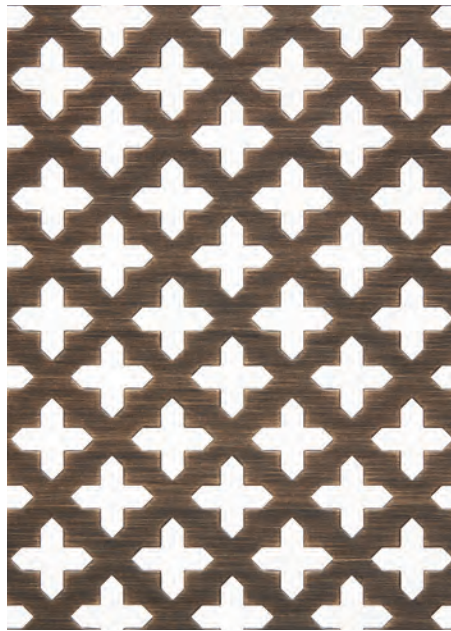

**Small cross**  
15mm point to point

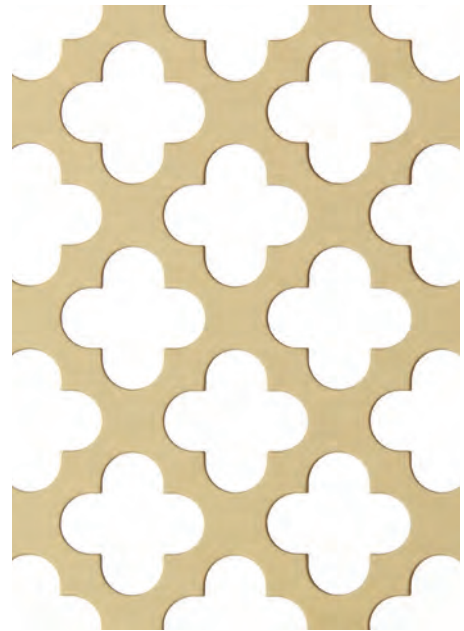

**Large club**  
19mm max width

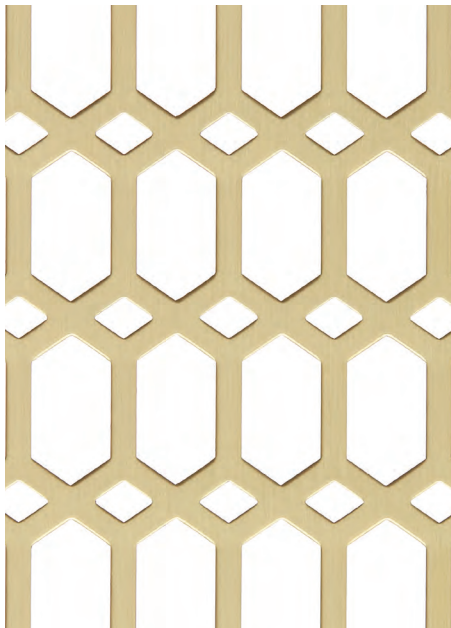

**Hexagonal**  
Internal lozenge 19mm (h) x 9.5mm (w)

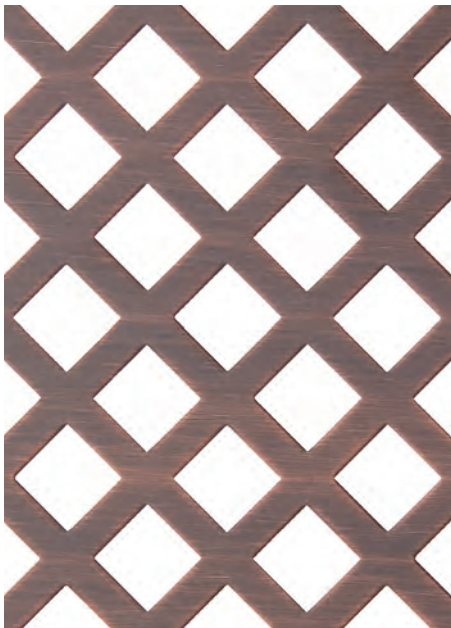

**Diamond**  
9.5mm internal square

### Specifications

- Available in standard full sheets, 2000mm x 1000mm
- Each perforated sheet measures at 2000mm x 1000mm. As the sheets have a small border, the patterned area of the sheet measures at 1970mm x 970mm
- Sheet thickness is 0.8mm
- Also available in aluminium, self-colour only
- Made cut to size

### Mesh options

Available with a number of mesh options, for more information, please see [page 121](#).

### Grille frame

Available with a metal frame, for more information, please see [page 120](#).

### Grille tolerance

All grilles are made to a 3.175mm ( $\frac{1}{8}$ " ) tolerance.

### Finish options

To see our 10 grille finishes in full, please turn to [page 100](#).

### Ordering your grille

Please turn to [page 122](#) for details on how to order your grille.



# Grille frames

All of the grilles featured in our product guide can be supplied with an added metal frame.

We offer four frame options: Angle, Channel, Flat and T-section, as pictured below.



Angle Section

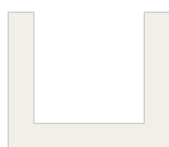

Channel Section

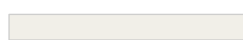

Flat Section



T-section

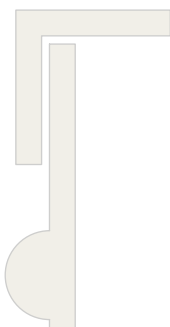

Angle Section  
attached to grille (side view)



Channel Section  
attached to grille (side view)



Flat Section  
attached to grille (side view)

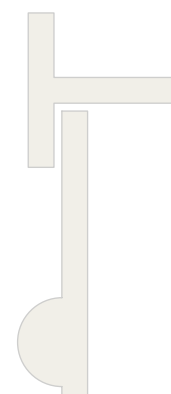

T-section  
attached to grille (side view)

## Additional information

- All frames can be supplied in either a 12.7mm, 19.1mm or 25.4mm face width
- Frames are made from solid brass 3.2mm thick section and can be finished to match the grille required
- Screw holes can be added to the face of the frame for fixing if required

# Mesh

Our brass mesh is used with many of our grilles as a backing, however, it can also be applied alone when something simpler is required.

## Additional information

- All available cut to size and also on a roll 1200mm high (approx. 4ft)
- All available in brass and stainless steel
- Finishes available on brass material only

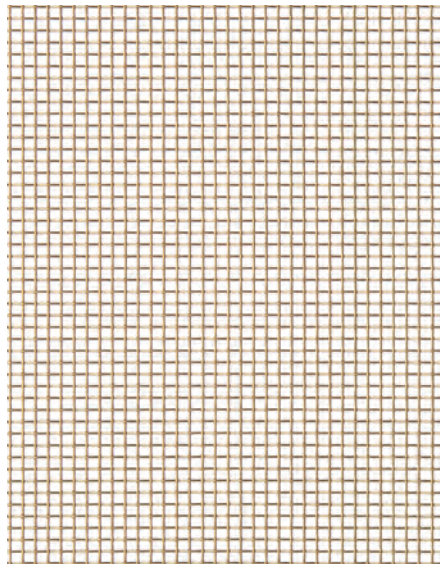

**Fine mesh brass**  
Square holes 1mm internal  
mesh 0.65mm thick

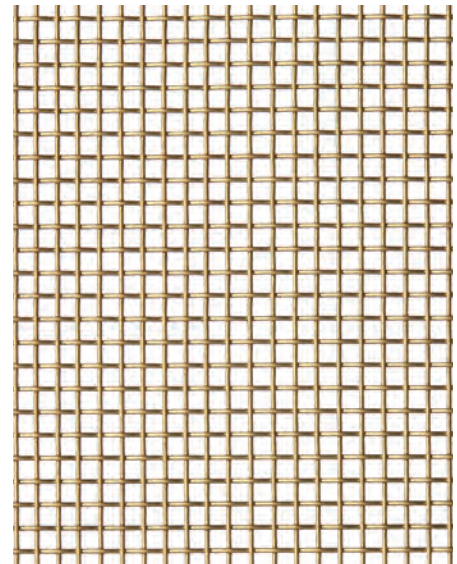

**Coarse mesh brass**  
Square holes 3mm internal  
mesh is 1.3mm thick

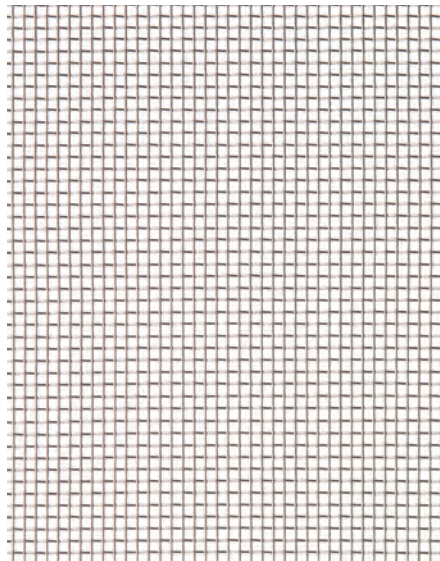

**Fine mesh stainless steel**  
Square holes 1mm internal  
mesh is 0.65mm thick

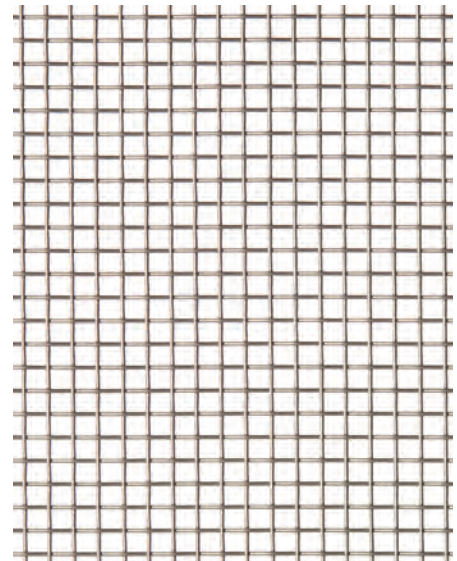

**Coarse mesh stainless steel**  
Square holes 3mm internal  
mesh is 1.3mm thick

## Finish options

To see our 10 grille finishes in full, please turn to [page 100](#).

## Ordering your grille

Please turn to [page 122](#) for details on how to order your grille.

## Ordering *your grille*

To place an order for a decorative grille, please email [sales@armacmartin.co.uk](mailto:sales@armacmartin.co.uk) with your enquiry. Please use the guide below to provide our team with as much information as possible.



### Required for all grilles

- Supply and identify the height and width of your panel. This should be the actual size you require, including the rebate of your door. Please allow 1.6mm all around to allow the grille to fit in your rebate comfortably
- Note the finish required
- Note if you require a metal frame

### Additional details

#### Regency Diamond and Georgian Square

- Advise if backing mesh is required and specify fine or coarse (**see page 121**)
- Advise if rosettes are required and if on every intersection or on alternate intersections

#### Elliptical grilles

- Note which way you require the ellipses to run - horizontally or vertically (**as pictured on page 104**)
- Advise if backing mesh is required and specify fine or coarse (**see page 121**)
- Advise if rosettes are required and if so which style

#### Interwoven grilles

- Note if you require a diamond, square or rectangular pattern
- Note the aperture size required
- Note if you'd like plain or reeded wires and the size required
- Advise if backing mesh is required and specify fine or coarse (**see page 121**)

#### Grille frames

- Note the type and size of frame required
- Supply the aperture (hole size) or overall size (including frame)
- Advise if screw holes are required in the frame for fixing

In-situ grille photographed in our polished brass unlacquered (PBUL) finish.





In-situ grille photographed in our antique brass lacquered (ABL) finish.





## ***Accessories collection***

Elevate your home decor with the finest luxury brass interior accessories. Made in England and available in our portfolio of finishes, from stylish shelf brackets and hooks to pot rails, mirrors and more, our luxury brass interior accessories transform functional design into a thing of timeless beauty.



# Claremont *mirrors*

Designed by eminent interior designer Sophie Paterson, the Claremont collection is a range of desirable luxury brass mirrors.



## Claremont Vanity Mirror

Code	Height (H)	Width (W)	Base width (BW)	Depth (D)	Mirror diameter (M)	Mirror weight
CLM/VAN	360mm	218mm	114mm	90mm	167mm	1.5kg

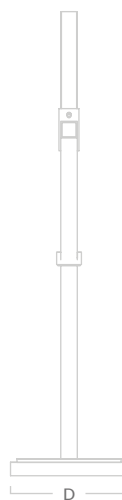
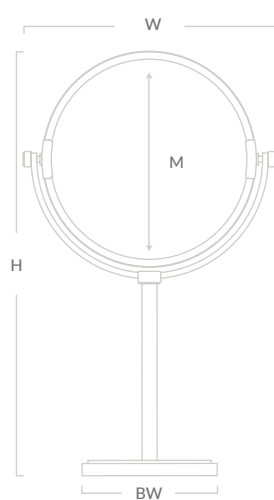

All products photographed in our satin antique satin lacquered (SAS) finish.

## Claremont Dressing Table Mirror

Code	Height (H)	Width (W)	Base width (BW)	Depth (D)	Mirror height (MH)	Mirror width (MW)	Mirror weight
CLM/DRS	505mm	356mm	200mm	150mm	315mm	275mm	7kg

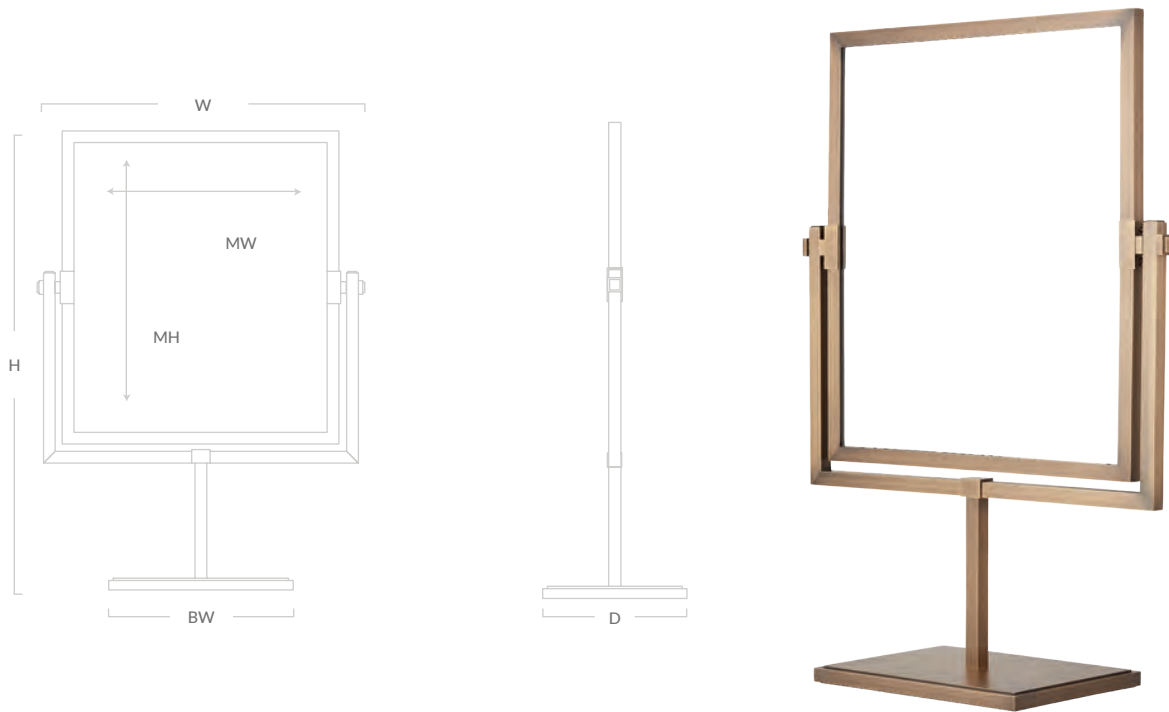

## Claremont Panelled Dressing Table Mirror

Code	Height (H)	Width (W)	Depth (D)	Mirror height (MH)	Mirror width (MW)	Side height (SH)	Side width (SW)	Mirror weight
CLM/PNL	650mm	770mm	230mm	574mm	324mm	574mm	123mm	16kg

Product photographed in our satin antique satin lacquered finish

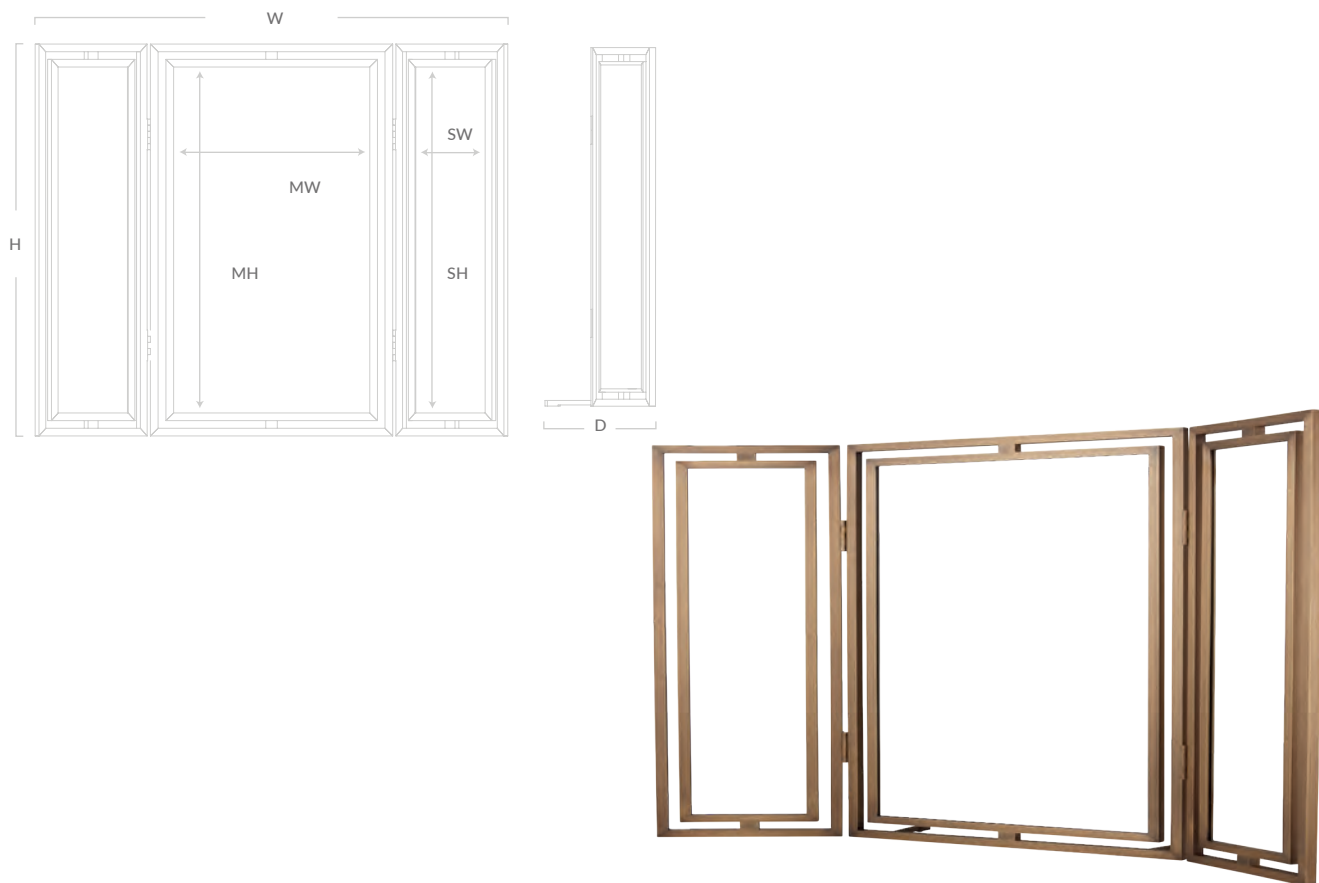

# Cotswold *brass rails*

Channel the classic country look in your kitchen with the Cotswold Brass Pot and Towel Rail, a traditional set designed to form part of our timeless Cotswold collection.



## Cotswold Brass Kitchen Towel Rail

Code	Centres (C)	Overall length (OL)	Bar length (BL)	Projection (P)	Diameter (D)	Bar diameter (BD)
COT/KITRAIL/500	449mm	574mm	424mm	90mm	51mm	22mm
COT/KITRAIL/900	849mm	900mm	824mm	90mm	51mm	22mm
COT/KITRAIL/1200	1149mm	1200mm	1124mm	90mm	51mm	22mm



All products photographed in our aged brass (BEL) finish.



## Cotswold Brass Pot Rail & S Hook

Code	Centres (C)	Overall length (OL)	Bar length (BL)	Projection (P)	Diameter (D)	Bar diameter (BD)	Hooks
COT/POTRAIL/500	450mm	500mm	425mm	90mm	51mm	22mm	4
COT/POTRAIL/900	850mm	900mm	825mm	90mm	51mm	22mm	6
COT/POTRAIL/1200	1150mm	1200mm	1125mm	90mm	51mm	22mm	8

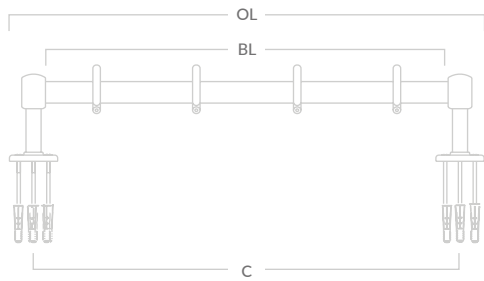

Code	Centres (C)	Overall length (OL)	Bar length (BL)	Projection (P)	Diameter (D)	Bar diameter (BD)	Hooks
COT/POTRAIL/1500	725mm	1500mm	700mm	90mm	51mm	22mm	10
COT/POTRAIL/1800	875mm	1800mm	850mm	90mm	51mm	22mm	10

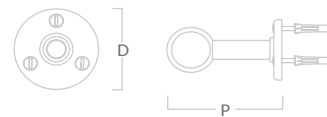
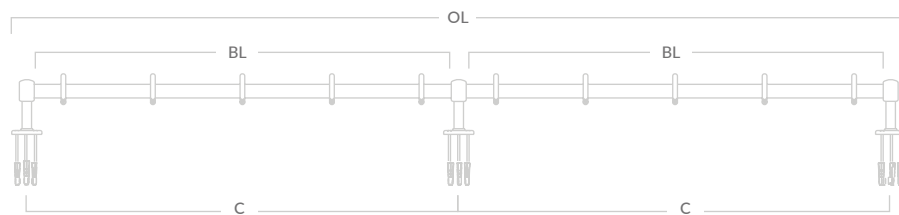

## Cotswold S Hook

Code	Radius (R)	Width (W)	Height (H)
COT/SHOOK	12mm	49mm	100mm

S hooks not suitable for for bars over 22mm diameter





Our Cotswold Towel Rail photographed in our aged brass (BEL) finish.

# Brindley *hanging wine glass rack*

A sophisticated way to display stemmed glassware whilst allowing for effortless access in kitchens and home bars, this wine glass rack adds interest and function.



## Brindley Hanging Wine Glass Rack

Code	Centres (C)	Hole centres (HC)	Overall length (OL)	Projection (P)	Y	X	Diameter (D)	Width (W)
BRI/WINERACK/254	44mm	238mm	254mm	42mm	27mm	51mm	6.35mm	114mm
BRI/WINERACK/400	44mm	384mm	400mm	42mm	27mm	51mm	6.35mm	114mm
BRI/WINERACK/600	44mm	584mm	600mm	42mm	27mm	51mm	6.35mm	114mm

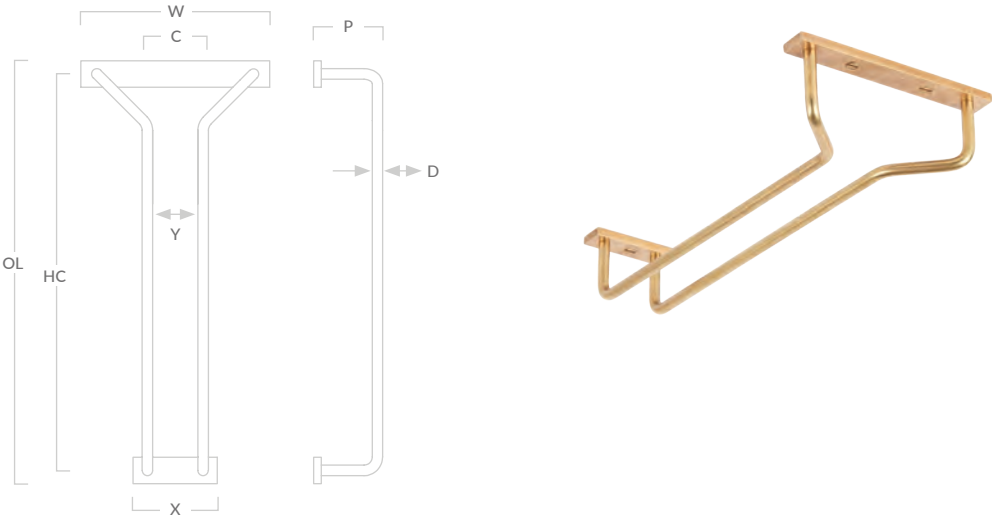

All products photographed in our aged brass (BEL) finish.



# Shelf *brackets*

Channeling a minimal aesthetic and focusing on flawless contours, accentuate your interiors with our collection of stylish shelf brackets.



## Harborne Shelf Bracket

Code	Width (W)	Centres (C)	Height (H)	Projection (P)	Shelf radius (R)	Shelf support (S)
HAB/BRKT/190	25mm	218mm	243mm	206mm	13mm	190mm
HAB/BRKT/250	25mm	290mm	315mm	266mm	13mm	250mm

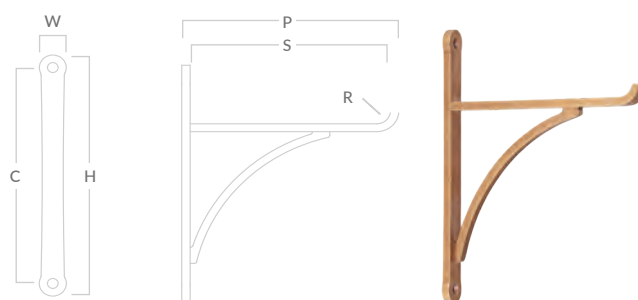

All products photographed in our aged brass (BEL) finish.

### Moseley Shelf Bracket

Code	Width (W)	Centres (C)	Height (H)	Projection (P)	Shelf support (S)
MOS/BRKT/190	19mm	226mm	245mm	198mm	190mm
MOS/BRKT/250	19mm	301mm	320mm	258mm	250mm

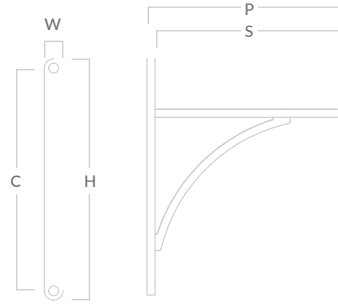

### Stirchley Shelf Bracket

Code	Width (W)	Centres (C)	Height (H)	Projection (P)	Shelf support (S)
STR/BRKT/190	19mm	215mm	245mm	198mm	190mm
STR/BRKT/250	19mm	290mm	320mm	258mm	250mm

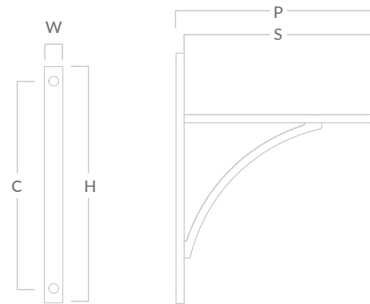

### Handsworth Flush Mounted Shelf Bracket

Code	Width (W)	Projection (P)	Height (H)	Centres (C)
HND/BRKT/190	19mm	198mm	185mm	146mm
HND/BRKT/250	19mm	258mm	259mm	205mm

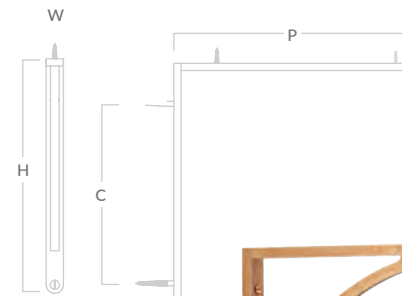

### Hockley Flush Mounted Shelf Bracket

Code	Width (W)	Projection (P)	Height (H)	Centres (C)
HOC/BRKT/190	19mm	198mm	185mm	140mm
HOC/BRKT/250	19mm	258mm	259mm	199mm

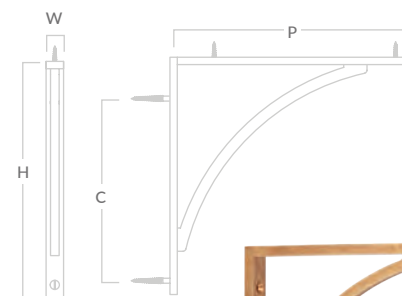

## Brass hooks

Add functional style to your interior with our collection of brass wall hooks. From traditional hat and coat hooks to modern robe hooks, each solid brass hook presents timeless appeal.



### MIX Diamond, Straight & Plain Single Vertical Hook

Code	Centres (C)	Bar diameter	Length (L)	Plate length (PL)	Projection (P)	Plate width (PW)
MIX1/V/HOOK/84	66mm	16mm	48mm	84mm	38mm	32mm



### Mix Diamond, Straight & Plain Single Horizontal Hook

Code	Centres (C)	Bar diameter	Length (L)	Plate length (PL)	Projection (P)	Plate width (PW)
MIX1/H/HOOK/84	66mm	16mm	48mm	84mm	38mm	32mm





## Mix Diamond, Straight & Plain Hook Rack

Code	Centres (C1)	Centres (C2)	Bar diameter	Plate length (PL)	Projection (P)	Plate width (PW)	Length (L)	Hooks
MIX1/HOOK/384	108mm	150mm	16mm	384mm	38mm	32mm	51mm	3
MIX1/HOOK/684	108mm	150mm	16mm	684mm	38mm	32mm	51mm	5

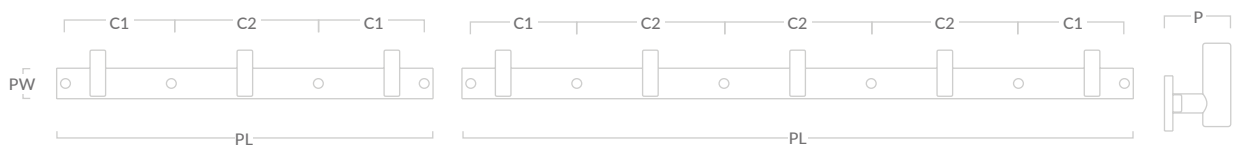

## Victoria Plain Hook

Code	Diameter (D)	Projection (P)	Base (B)
VIC/HOOK/PLAIN/25	25mm	40mm	25mm

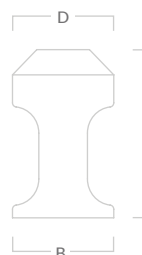

## Victoria Stepped Hook

Code	Diameter (D)	Projection (P)	Base (B)
VIC/HOOK/25	25mm	40mm	25mm



## Barwick Ridged Hook

Code	Diameter (D)	Projection (P)	Base (B)
BWK/HOOKONLY/22	22mm	32mm	13mm

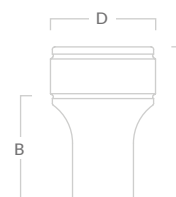

## Barwick Ridged Hook with Backplate

Code	Diameter (D)	Projection (P)	Plate length (PL)	Plate width (PW)
BWK/HOOK/22	22mm	35mm	56mm	28mm

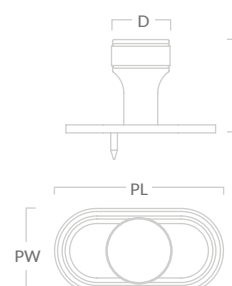

### Barwick Plain Hook

Code	Diameter (D)	Projection (P)	Base (B)
BWK/HOOKONLY/PLAIN/22	22mm	32mm	13mm

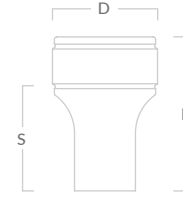

### Barwick Plain Hook with Backplate

Code	Diameter (D)	Projection (P)	Plate length (PL)	Plate width (PW)
BWK/HOOK/PLAIN/22	22mm	35mm	56mm	28mm

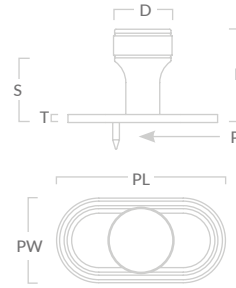

### Colmore Hook

Code	Diameter (D)	Projection (P)	Base (B)
COL/HOOK/27	27mm	27mm	16mm
COL/HOOK/32	32mm	32mm	23mm
COL/HOOK/38	38mm	38mm	26mm
COL/HOOK/45	45mm	40mm	32mm



### Digbeth Plain Hook

Code	Projection (P)	Plate width (PW)	Plate length (PL)
DIG/HOOK/PLAIN/48	39mm	25mm	58mm

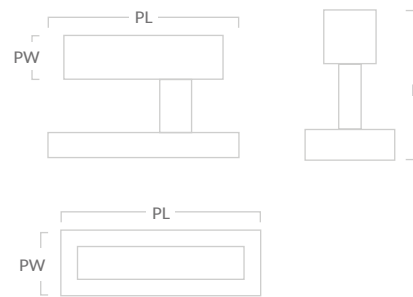

### Digbeth Ridged Hook

Code	Projection (P)	Plate width (PW)	Plate length (PL)
DIG/HOOK/48	39mm	25mm	58mm

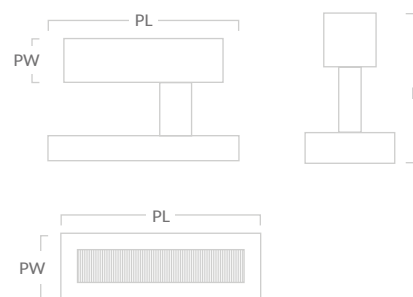

### Grove Hook

Code	Projection (P)	Diameter (D)
GRV/HOOK/34	34mm	19mm



### Single Hook

Code	Projection (P)	Height (H)
0783/38	38mm	47mm
0783/50	52mm	54mm
0783/64	54mm	58mm

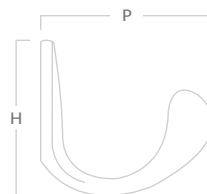

### Sliding Wardrobe Hook

Code	Projection (P)	Height (H)	Fits tube diameter
0789/19	49mm	55mm	19mm
0789/25	54mm	63mm	25mm



### Hat & Coat Hook

Code	Projection (P)	Height (H)
0810/127	55mm	118mm
0810/152	75mm	135mm

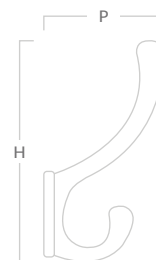

### Rectangular Hat & Coat Hook

Code	Projection (P)	Height (H)
0820/114	87mm	87mm

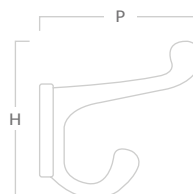

### Double Hook

Code	Projection (P)	Height (H)
0845/64	24mm	45mm
0845/70	26mm	49mm



### Single Square Hook

Code	Projection (P)	Height (H)
2109/38	45mm	40mm

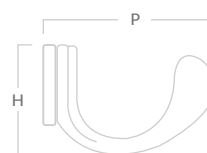



# Cabinet *hinges*

Our solid brass hinges provide the finishing functional touch to your cabinetry. Our solid brass butt hinges offer strength and durability whilst ensuring smooth closure of doors. Screws sold separately. All hinges are sold in pairs.

Code	Height (H)	Width (W)	Hinge screws
204/38	38mm	23mm	4g
204/50	50mm	28mm	6g
204/64	64mm	35mm	6g
204/76	76mm	42mm	6g

Code	Height (H)	Width (W)	Hinge screws
207/50	50mm	38mm	6g
207/64	64mm	38mm	8g
207/76	76mm	50mm	8g

Code	Height (H)	Width (W)	Hinge screws
207/50/1SLOT	50mm	38mm	6g
204/76/1SLOT	76mm	42mm	8g

Code	Height (H)	Width (W)	Hinge screws
207/50/2SLOT	50mm	38mm	6g
204/64/2SLOT	76mm	42mm	6g

Code	Height (H)	Width (W)	Hinge screws
2300/50	50mm	38mm	6g
2300/64	64mm	50mm	6g
2300/76	76mm	50mm	6g

Code	Height (H)	Width (W)	Hinge screws
205/65	63.5mm	14mm	4g
205/75	75mm	24mm	4g

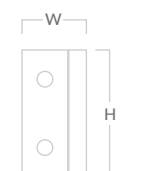
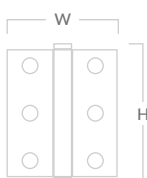
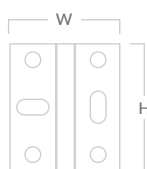
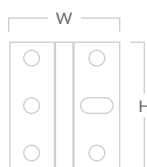
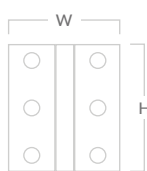
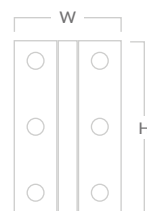

# Card frames

A traditional detail for pantries and home offices, our solid brass cardframes are supplied with screws.

Code	Width (W)	Height (H)	Window
0788/50	50mm	25mm	36 x 16mm
0788/64	63.5mm	38mm	46 x 23mm
0788/76	76mm	50mm	55 x 36mm

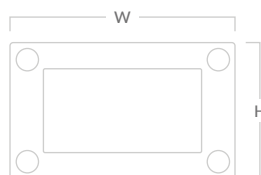

Code	Width (W)	Height (H)	Projection	Window
1845/64	61mm	38mm	19mm	44 x 14mm



Code	Width (W)	Height (H)	Projection	Window
2091/64	62mm	57mm	20mm	42 x 21mm

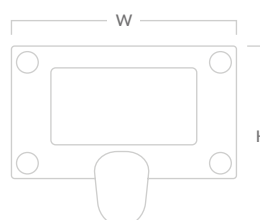

Code	Width (W)	Height (H)	Window
2054/120	120mm	51mm	88 x 36mm



Code	Width (W)	Height (H)	Projection	Window
2541/95	96mm	74mm	25mm	72 x 24mm



# Magnetic catches

For cabinet closure, our solid brass magnetic catches are supplied with screws.

## LELo1 Silent Magnetic Catch (5kg magnet pull strength)



Bronze



Black nickel



Chrome



Gilt

## LM5402 Face Fix Magnetic Catch (4kg magnet pull strength)



Bronze



Nickel



Chrome



Gilt

## LM5103 Face Fix Magnetic Catch (4kg magnet pull strength)



Bronze



Bright Nickel



Chrome



Gilt



Nickel



# Finials & screws

Discover our range of solid brass finials and fixing screws to complete your hardware and accessories.

Finials sold in sets of 4.  
To be ordered for use with our hinges.

Code	Projection	Diameter
2301/BALL (SET OF 4)	10mm	6mm

2301/BALL and 2301/URN finials are for use with 2300 hinges only



Code	Projection	Diameter
2301/STEEPLE (SET OF 4)	22mm	6mm

2301/BALL and 2301/URN finials are for use with 2300 hinges only



## Pozi Screws

Code	Height	Width
SBF12/P/6x3/4	6g	19mm
SBF12/P/8x3/4	8g	19mm

Screws sold in sets of 12



## Slotted Screws

Code	Height	Width
SBF12/S/6x3/4	6g	19mm
SBF12/S/8x3/4	8g	19mm

Screws sold in sets of 12





Our Bakes and Queslett collections photographed in our hand burnished brass (HBB) finish.



## Contact *us*

We'd love to be part of your project

We hope you have enjoyed exploring our Product Guide and discovering our luxury brass hardware and accessories collections.

For further assistance or samples, please use the contact details below.

[sales@armacmartin.co.uk](mailto:sales@armacmartin.co.uk) | [armacmartin.co.uk](http://armacmartin.co.uk) | [@armacmartin](https://www.instagram.com/armacmartin)



+44121 359 2111

Monday to Thursday (8am - 5pm)

Friday (8am - 1pm)

Please note our office hours are GMT



# Acknowledgements

## Thank you

Design by Sophie Paterson Interiors. Photography by Ray Main.	2
Quinton - Design by Sola Kitchens. Photography by Chris Snook.	20
Jaspette - Design by Thorpe Concepts. Photography by Interiors by Young Glass.	21
Bromsgrove - Design by JK Interior Living. Photography by Linda Pordon.	23
Arbar - Design by Brownlow Furniture. Photography by Mark Reeves.	24
Longbridge - Design by RK Designs.	26
Edgbaston - Design by Andrea Benedettini. Photography by Julian Abrams.	27
Crossways - Design by Sophie Paterson Interiors. Photography by Ray Main.	28
Aberdovey - Design by Victoria Summer. Photography by Handover.	30
Bournville - Design by Atelier.	31
Cotswold - Design by Claire Totman. Photography by Sarah Griggs.	32
Design by Ashley Montgomery. Photography by Lauren Miller.	34
Bakes - Design by Peden & Pringle. Photography by Paul Craig.	36
Bakes - Design by Kate Feather Design. Photography by Birgit Mons.	37
Queslett - Design by Himlekök and Refine Design Studio. Photography by Osman Tahir.	38
Withenshaw - Design by Laura Butler-Madden. Photography by Patrick Butler-Madden.	40
Washwood - Design by Laura Butler-Madden. Photography by Patrick Butler-Madden.	41
Bromford - Design by Woodale Designs.	44
Kingsheath - Design by Cherished Bliss.	45
Sparkbrook - Design by Abington Design House. Photography by Jamie Hackett Photography.	46
Leebank - Design by Blakes London.	48
Carlton - Design by Andrea Benedettini. Photography by Ray Main.	49
Lincoln - Design by Krantz Designs. Photography by Paul Craig.	50
Rotunda - Design by La Maison.	51
Jefferson - Design by Sophie Paterson Interiors. Photography by Ray Main.	52
Gaumont - Design by Sophie Paterson Interiors. Photography by Ray Main.	53
Sutton - Photography by Gregory Croxford Living.	54
Belgrave - Design by The Cabinet Gallery Utah.	55
Snowdrift - Design by Sophie Paterson Interiors. Photography by Ray Main.	56
Merrick - Design by Rosewood Luxury Developments. Photography by Handover.	57
Latchford - Design by JK Interior Living. Photography by Linda Pordon.	58
Design by Amanda Teal and Segale Bros Wood Products. Photography by R. Brad Knipstein.	59

Digbeth Ridged - Design by Kate Marker Interiors. Photography by Stoffer Photography Interiors.	<b>70</b>
Digbeth Plain - Design by McCroskey Interiors. Photography by Kevin Miyazake.	<b>72</b>
MIX Diamond - Design by Money Hill Interiors.	<b>74</b>
MIX Straight - Design by Jean Stoffer. Photographed by John Stoffer.	<b>76</b>
MIX Plain - Design by Thorpe Concepts. Photography by Interiors by Young Glass.	<b>78</b>
Bromwich - Design by Michael Farrell. Photography by Infinity Media.	<b>80</b>
Victoria Plain - Design by Summer House Interiors.	<b>85</b>
Oblique - Design by McCroskey Interiors.	<b>88</b>
Quadrille - Design by Bespoke of Winchester.	<b>89</b>
Dougan - Design by Noel Dempsey Design.	<b>90</b>
Dougan - Design by Bondi Kitchens. Photography by Jacqui Turk.	<b>91</b>
Grove - Design by Sophie Paterson Interiors. Photography by Ray Main.	<b>92</b>
Harold - Design by Atelier Cabinet Makers.	<b>94</b>
Grille finishes - Design by Naked Kitchens.	<b>100</b>
Regency Diamond Grille - Design by McCroskey Interiors. Photography by Nate Sheet.	<b>102</b>
Georgian Square Grille - Design by Barr Joinery. Photography by Lucy Butler-Walters.	<b>106</b>
Diamond Interwoven Grille - Design by Sophie Paterson Interiors. Photography by Ray Main.	<b>108</b>
Square Interwoven Grille - Design by Becky Shea Design & Bakes & Kropp.	<b>110</b>
Double Diamond Interwoven Grille - Design by Louise Bramhill. Photography by Susie Lowe.	<b>114</b>
Double Rectangular Interwoven Grille - Design by St Giles Furniture. Photography by Chris Wharton.	<b>116</b>
Perforated Sheet Grille - Design by Peden & Pringle. Photography by Paul Craig.	<b>118</b>
Ordering your grille - Design by Kitchen Cove Design Studio. Photography by Erin Little.	<b>122</b>
Ordering your grille - Design by Krantz Design. Photography by Paul Craig.	<b>123</b>
Claremont - Sophie Paterson Interiors. Photography by Ray Main.	<b>126</b>
Cotswold Pot Rail - Design by Atelier Cabinet Makers.	<b>128</b>
Towel Rail - Photography by Handover.	<b>130</b>
Brindley Hanging Wine Glass Rack - Design by Naked Kitchens.	<b>131</b>
Shelf Brackets - Design by Laura Butler-Madden. Photography by Patrick Butler-Madden.	<b>132</b>
Wall Hooks - Photography by Handover.	<b>134</b>
Design by AKB Design. Photography by Maxime Desbiens.	<b>142</b>
Design by McCroskey Interiors. Photography by Nate Sheet.	<b>146</b>





Our MIX and Latchford collections photographed in our aged brass (BEL) finish.





Made in England *since 1929*

