

BUSTER+PUNCH
LONDON



HARDWARE

ROW EDIT



**BUSTER + PUNCH STARTED IN A GARAGE IN
EAST LONDON, BUILDING CUSTOM MOTORBIKES.**

Our love for working with rare, solid metals has led us to transform everyday functional fittings into extraordinary home essentials.

From the light bulb, the dimmer switch and the pendant lamp to the door handle and the cabinet pull, Buster + Punch has created an innovative collection of unexpected design details.

BUSTERANDPUNCH.COM



[page 06-35. **CABINET HARDWARE.**]

[page 36-57. **DOOR HARDWARE.**]

[page 58-61. **FINISHES.**]

[page 62-69. **ENTIRE COLLECTION.**]

[page 70-71. **OUR WORLD.**]

[page 72-73. **OUR DESIGNER.**]

[category. **CABINET HARDWARE.**]

A collection of unique kitchen handles, cabinet pulls, drawer knobs, door pulls and furniture hardware. Crafted from solid metal, using a diamond-edge cnc lathe and featuring either our signature cross-knurl pattern or our elegant linear-knurl pattern. Refined by hand.

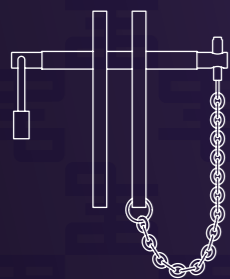



[collection. **LINEAR.**]

Our new linear-knurl pattern is machined into 12mm diameter solid bar and inspired by fashion accessory hardware. Elegant in look and scale this knurl is beautifully refined. The linear-knurl is accompanied by machined torx screws.







FURNITURE KNOB / LINEAR

[knurl.] **LINEAR.]**

[details.] **SOLID METAL.]**

[fyi.] **SOLD IN SETS OF TWO.]**

[finish.]
STEEL.] 
BRASS.] 
GUN METAL.]  ◀
BLACK.] 



[dimensions.]



[scale.]

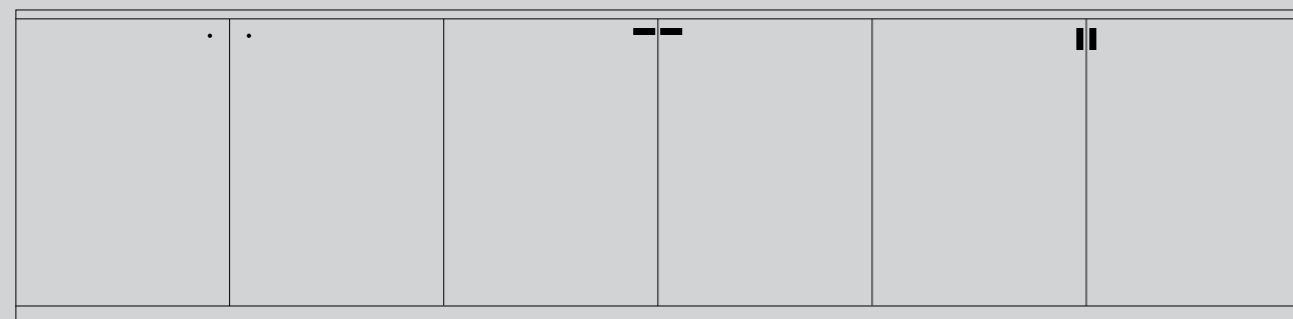





FURNITURE KNOB / PLATE / LINEAR

[knurl.] **LINEAR.]**

[details.] **SOLID METAL.]**
BACKPLATE.]
COIN SCREWS.]

[fyi.] **SOLD IN SETS OF TWO.]**

[finish.]
STEEL.] 
BRASS.]  ◀
GUN METAL.] 
BLACK.] 



[dimensions.]

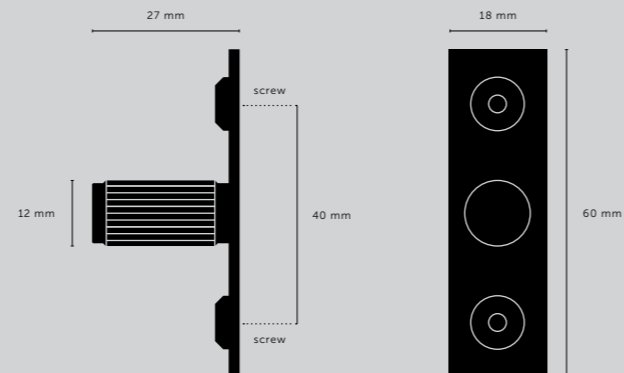

PULL BAR / LINEAR

[size.]
SMALL.]
MEDIUM.]
LARGE.]

[finish.]
STEEL.]
BRASS.] ◀
GUN METAL.]
BLACK.]

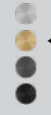

[knurl.]
LINEAR.]

[details.]
SOLID METAL.]
TORX SCREW ENDS.]

[product image.]



[dimensions.]

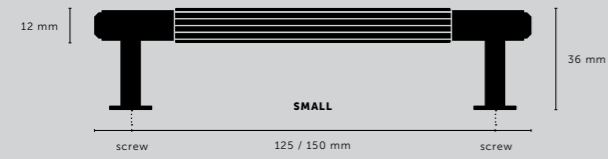
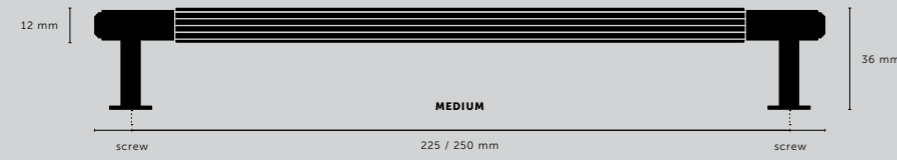
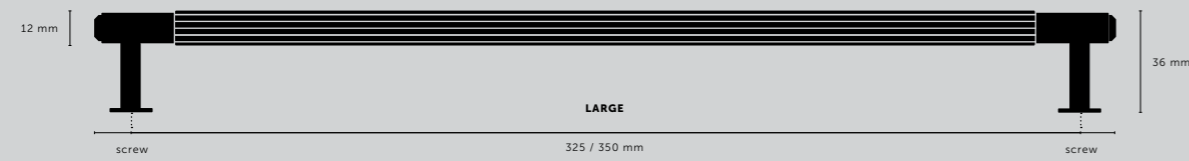





[scale.]

900 mm counter



PULL BAR / PLATE / LINEAR

[size.]
SMALL.]
MEDIUM.]
LARGE.]

[finish.]
STEEL.] 
BRASS.] 
GUN METAL.] 
BLACK.] 

[knurl.]
LINEAR.]







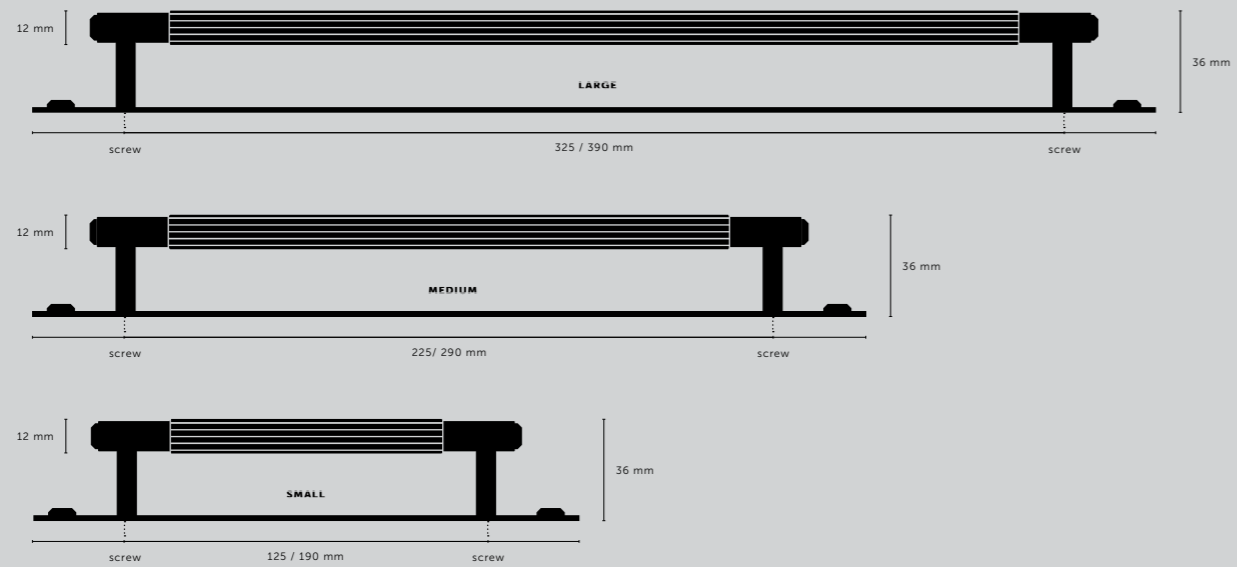











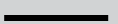
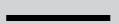
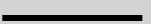
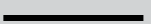

[details.]
SOLID METAL.]
BACKPLATE.]
TORX SCREWS.]



[dimensions.]



[scale.]

900 mm counter



[size.] **LARGE.]**
 [finish.] **BRASS.]**

L-BAR / LINEAR

[knurl.] **LINEAR.]**

[finish.]

STEEL.]
BURNT STEEL®.]
BRASS.]
GUN METAL.]
BLACK.]



[details.] **SOLID METAL.]**
MACHINED STALK.]
TORX SCREW END.]

[dimensions.]

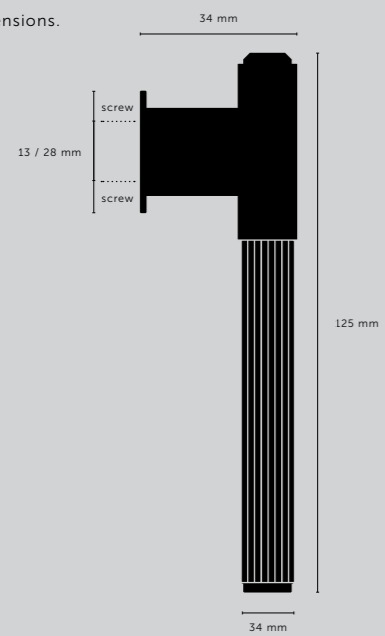

[product image.]



[scale.]

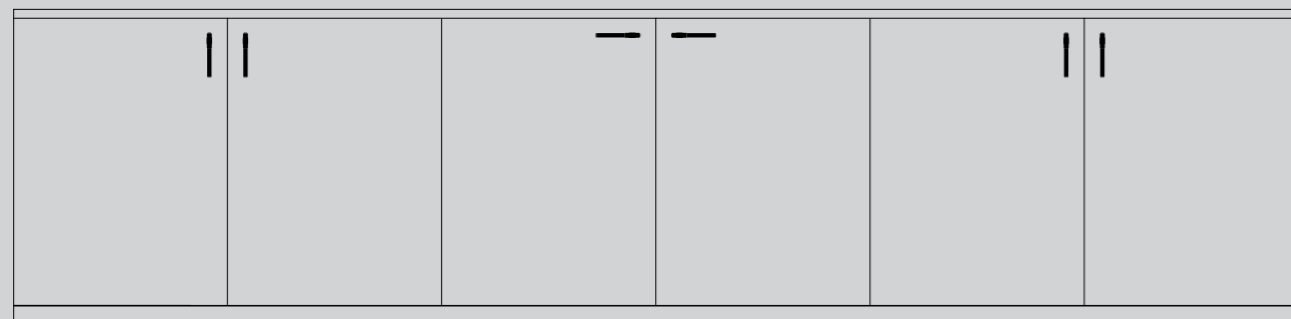

PRECIOUS BAR / LINEAR

[knurl.]

LINEAR.]

[product image.]



[details.]

**SOLID METAL.]
PADLOCK + CHAIN.]**

[fyi.]

**INCLUDES B+P LOW SECURITY
PADLOCK AND KEY.]**

[finish.]

BURNT STEEL®.]  **BRASS.]** 

[dimensions.]

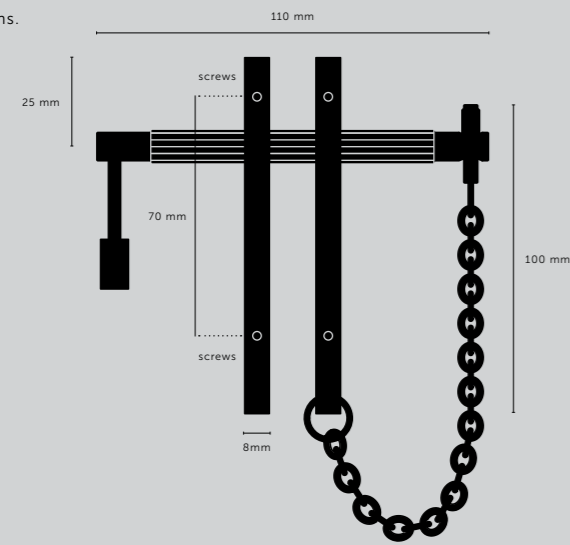

[scale.]

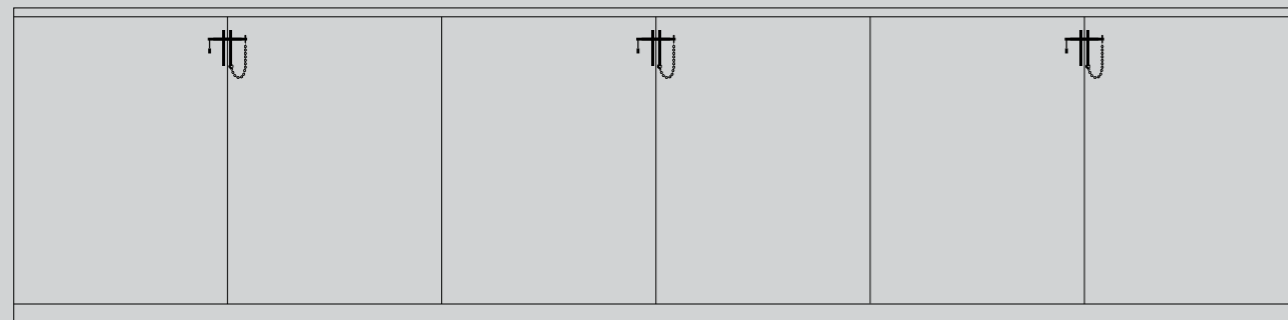

[category.]
[page.]

**CABINET HARDWARE.]
18.]**



[detail.]
[finish.]

**PADLOCK + CHAIN.]
BRASS.]**

[category.]
[page.]

**CABINET HARDWARE.]
19.]**



[collection. **CROSS.**]





Our signature cross-knurl pattern is diamond-cut into 20mm diameter solid bar and inspired by machinery. Industrial in look and scale this knurl feels amazing under touch. The cross-knurl is accompanied by our signature solid metal coin screws.

FURNITURE KNOB / CROSS

[knurl.] **CROSS.]**

[details.] **SOLID METAL.]**

[fyi.] **SOLD IN SETS OF TWO.]**

[finish.]
STEEL.] 
BRASS.] 
SMOKED BRONZE.] 
BLACK.] 



[dimensions.]

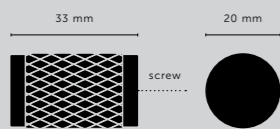

[scale.]

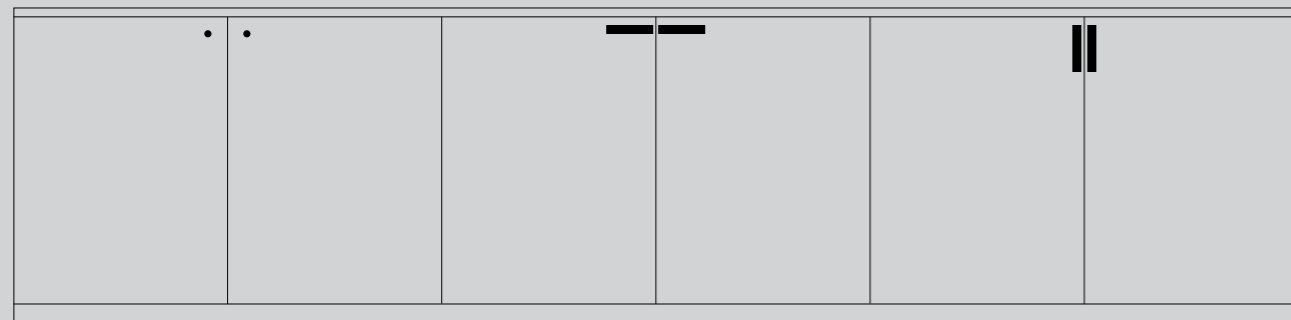





FURNITURE KNOB / PLATE / CROSS

[knurl.] **CROSS.]**

[details.] **SOLID METAL.]**
BACKPLATE.]
COIN SCREWS.]

[fyi.] **SOLD IN SETS OF TWO.]**

[finish.]
STEEL.] 
BRASS.] 
SMOKED BRONZE.] 
BLACK.] 



[dimensions.]

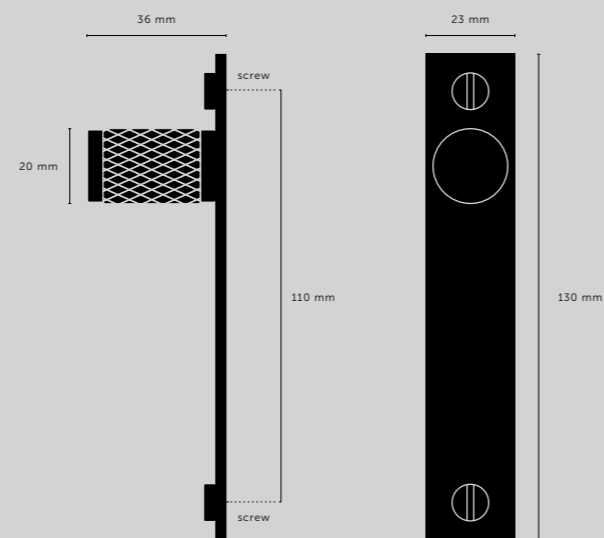

[type.] **FURNITURE KNOB / PLATE.]**
 [finish.] **BRASS.]**

PULL BAR / CROSS

[size.]
SMALL.]
MEDIUM.]
LARGE.]

[finish.]
STEEL.]
BRASS.]
SMOKED BRONZE.]
BLACK.]

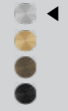

[knurl.]
CROSS.]

[details.]
SOLID METAL.]
COIN SCREW ENDS.]

[product image.]



[fyi.]
DOUBLE-SIDED VERSION AVAILABLE PG. 48.]

[dimensions.]

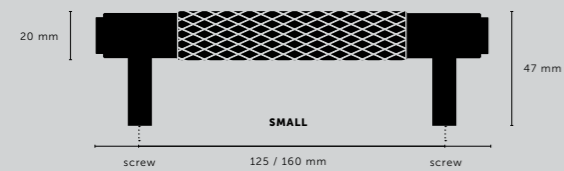
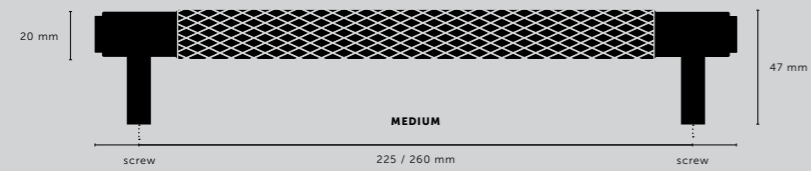
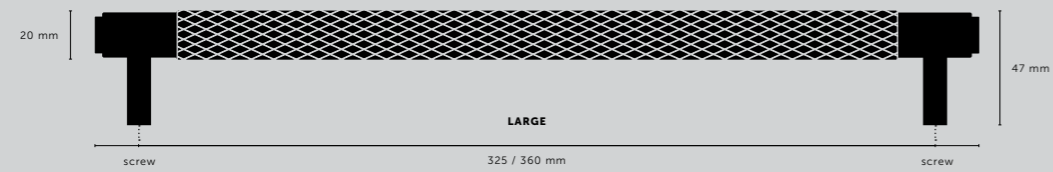

[scale.]

900 mm counter



[size.]
MEDIUM & LARGE.]
[finish.]
SMOKED BRONZE.]

PULL BAR / PLATE / CROSS

[size.]
SMALL.]
MEDIUM.]
LARGE.]

[finish.]
STEEL.]
BRASS.]
SMOKED BRONZE.] ◀
BLACK.]

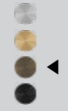

[knurl.]
CROSS.]

[details.]
SOLID METAL.]
BACKPLATE.]
COIN SCREWS.]

[product image.]



[dimensions.]

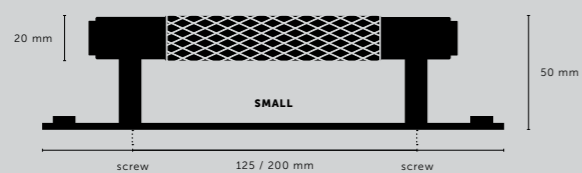
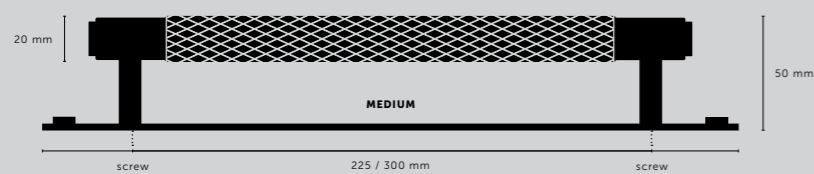
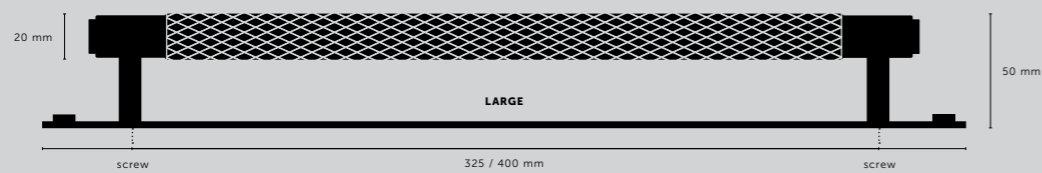

[scale.]

900 mm counter



[size.]
LARGE.]
[finish.]
STEEL.]

CLOSET BAR / CROSS

[knurl.] **CROSS.]**

[finish.] **STEEL.]**

BRASS.]

SMOKED BRONZE.]

BLACK.]



[details.] **SOLID METAL.]**
COIN SCREW ENDS.]

[details.] **COMES WITH 2 X 24 MM SMALL DISCS.]**
FITS THROUGH CABINET DOOR FROM BACKSIDE.]
DOUBLE-SIDED VERSION AVAILABLE PG. 50.]

[product image.]



[dimensions.]

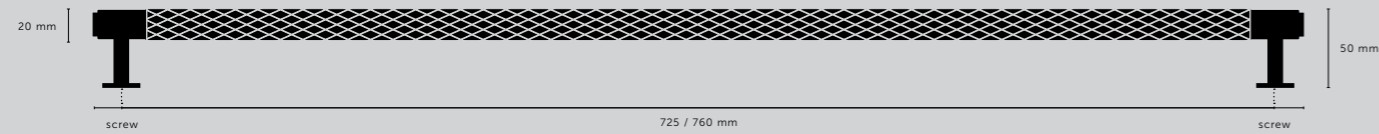

[scale.]

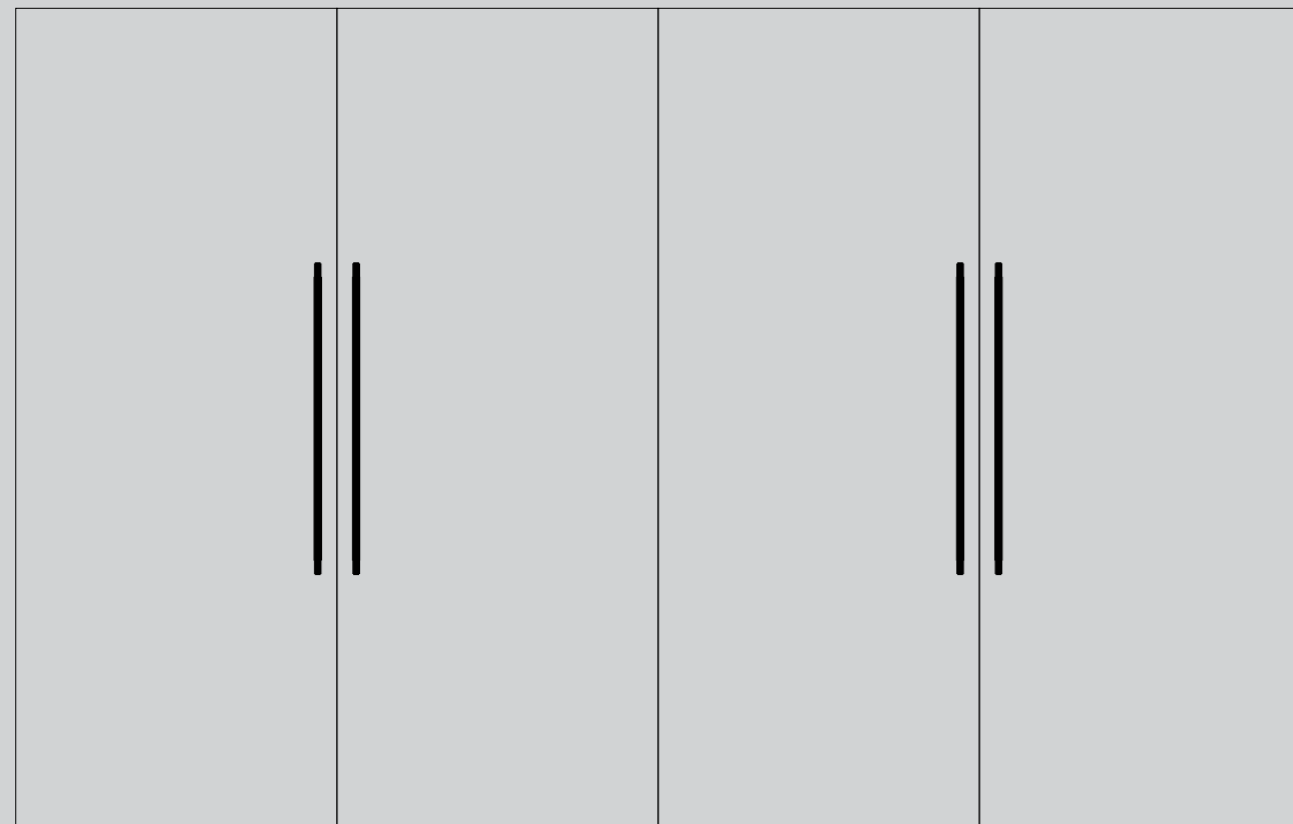

2040 mm closet







[knurl.]
[finish.]

CROSS.]
SMOKED BRONZE.]

T-BAR / CROSS

[knurl.] **CROSS.]**

[details.] **SOLID METAL.]**

[finish.]
STEEL.] 
BRASS.] 
SMOKED BRONZE.] 
BLACK.] 

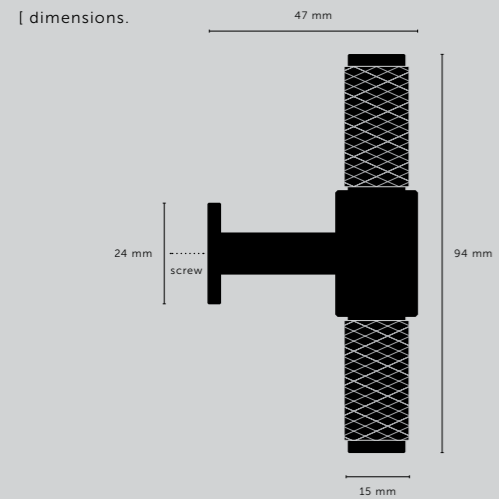



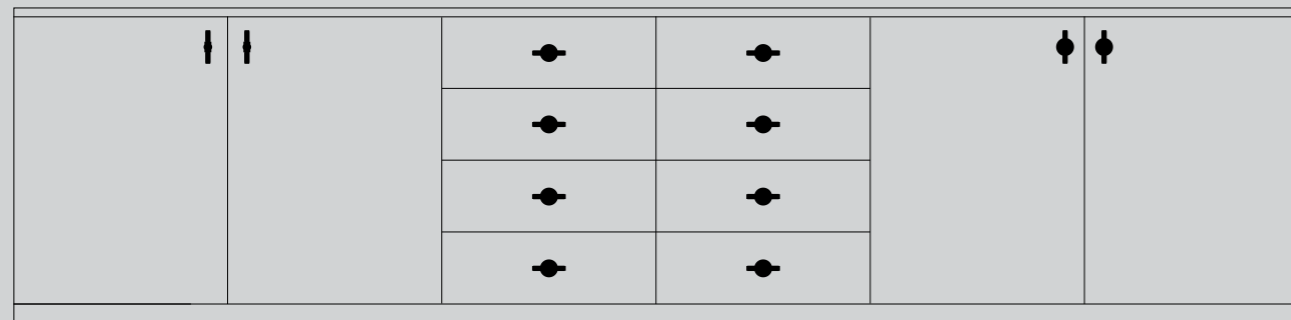

[scale.]



T-BAR / PLATE / CROSS

[knurl.] **CROSS.]**

[details.] **SOLID METAL
 BACKPLATE.]
 COIN SCREWS.]**

[finish.]
STEEL.] 
BRASS.] 
SMOKED BRONZE.] 
BLACK.] 

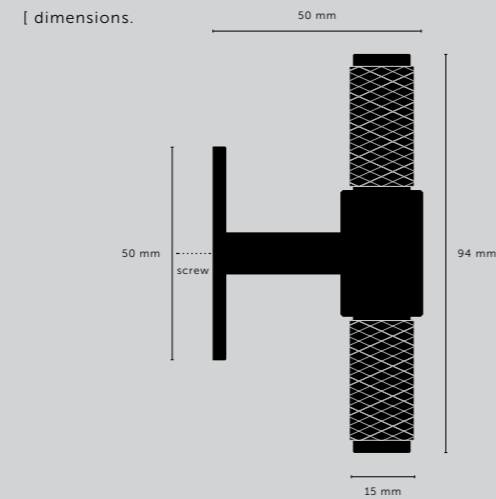

[scale.]



[product.] **T-BAR.]**
 [finish.] **BRASS.]**

[scale. **LINEAR vs CROSS.**]

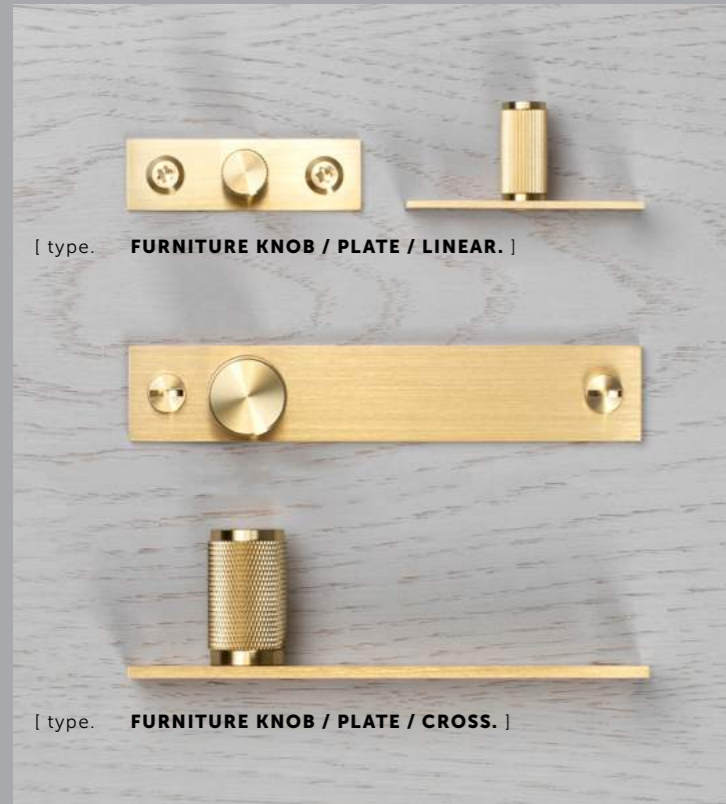

THE HOOK

[knurl.] **CROSS.]**
[details.] **SOLID METAL.]**
MACHINED HEAD.]
[fyi.] **COMES WITH WALL ANCHOR INSERT.]**

[finish.] **STEEL.]**
BRASS.] ◀
SMOKED BRONZE.] ●

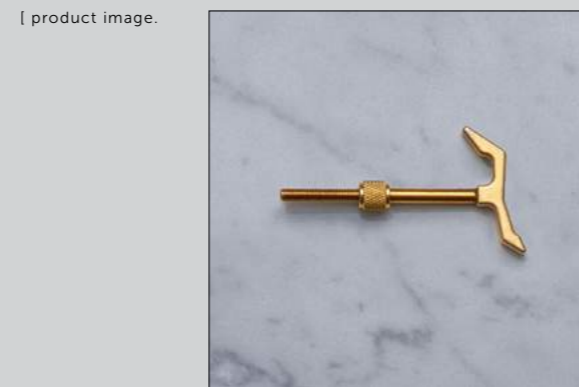
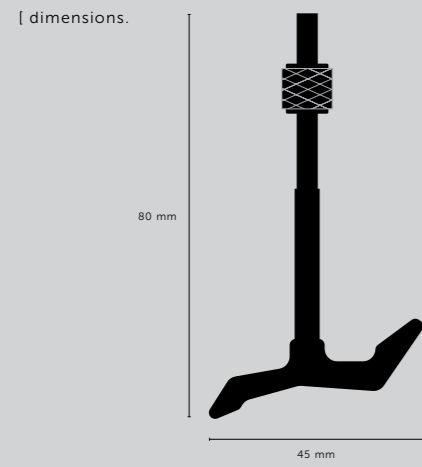

[category. **DOOR HARDWARE.**]

A collection of bold door handles, door knobs, door stops, door pulls and door accessories. Fashioned from solid metal, using a diamond-edge cnc lathe and featuring our signature cross-knurl pattern. Refined by hand.

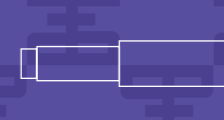
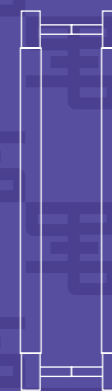

DOOR HANDLE / CROSS

[knurl.] **CROSS.]**

[action.] **SPRUNG.]**

[motion.] **LEVER.]**

[details.] **SOLID METAL.]**
COIN SCREW END.]
DIAMOND-CNC LATHE PROCESS.]

[dimensions.]

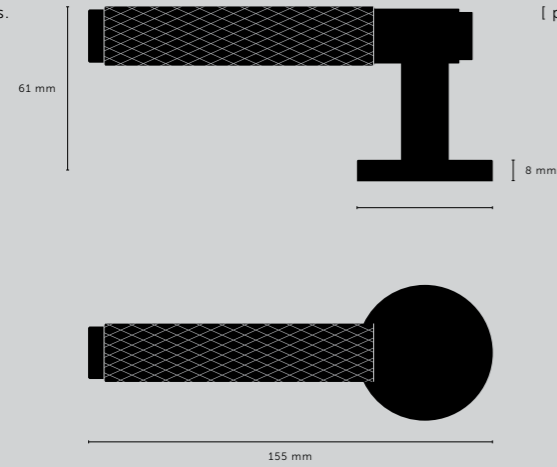

[product image.]



[finish.]

STEEL.]
BRASS.]
SMOKED BRONZE.]
BLACK.]

[fyi.]

SOLD IN PAIRS.]
CENTRE-DISTANCE 38 MM.]
SPRING ASSISTED ROSE TO ENSURE HANDLE RETURNS TO CENTRE.]
FITS DOORS OF THICKNESS 35 - 54MM WITH SUPPLIED FITTINGS.]
INTERIOR USE ONLY.]
FOR USE IN UK & PARTS OF EU OR ROW IF USING OUR LATCHES.]

FIXED DOOR HANDLE / CROSS

[knurl.] **CROSS.]**

[motion.] **FIXED.]**

[details.] **SOLID METAL.]**
COIN SCREW END.]
DIAMOND-CNC LATHE PROCESS.]

[dimensions.]

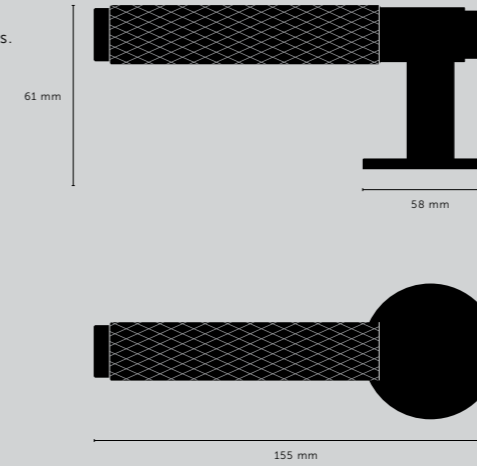

[product image.]



[finish.]

STEEL.]
BRASS.]
SMOKED BRONZE.]
BLACK.]

[fyi.]

SOLD AS A SINGLE HANDLE.]
HANDLE REMAINS IN FIXED POSITION.]
CAN BE FITTED TO ANY DOOR.]
INTERIOR USE ONLY.]

DOOR HANDLE / CROSS

[knurl.] **CROSS.]**

[action.] **UNSPRUNG.]**

[details.] **SOLID METAL.]**
COIN SCREW END.]
DIAMOND-CNC LATHE PROCESS.]

[dimensions.]

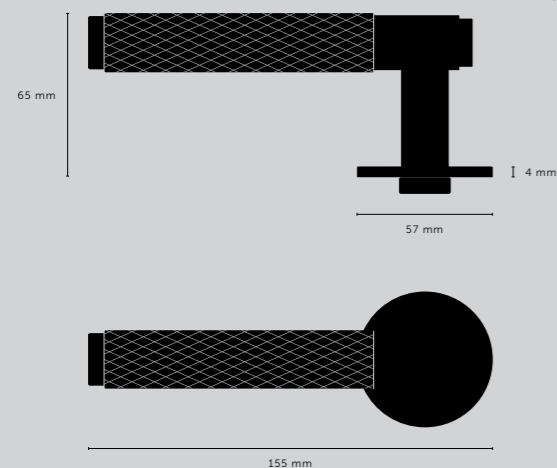

[product image.]



[finish.]

STEEL.]
BRASS.]
SMOKED BRONZE.]
BLACK.]

[fyi.]

SOLD IN PAIRS.]
CENTRE-DISTANCE 30 MM (SWEDEN).]
CENTRE-DISTANCE 38MM (UK)* TRADE PRODUCT ONLY.]
CAN ONLY BE USED WITH HEAVILY SPRUNG LATCHES.]
FITS DOORS OF THICKNESS 35 - 54MM WITH SUPPLIED FITTINGS.]
INTERIOR USE ONLY.]



[knurl.] **CROSS.]**
[finish.] **BRASS.]**

DOOR KNOB / CROSS

[knurl.] **CROSS.]**

[action.] **UNSPRUNG.]**

[motion.] **TWIST.]**

[details.] **SOLID METAL.]**
DIAMOND-CNC LATHE PROCESS.]

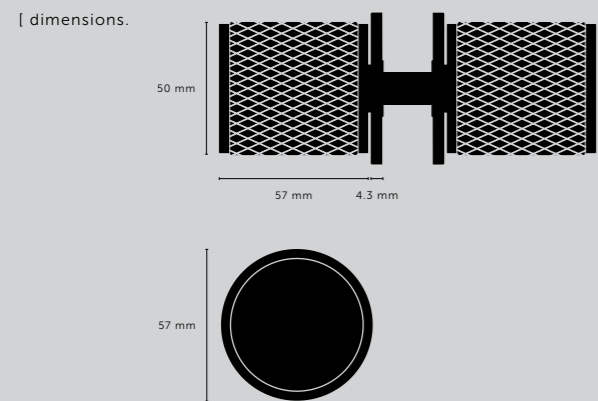

[finish.] **STEEL.]** ◀
BRASS.] ◀
BLACK.] ◀

[fyi.] **SOLD IN PAIRS.]**
PASSAGE.]
CENTRE-DISTANCE 30 MM (SWE), 38 MM (UK), 41.5 MM (ANZS).]
FOR USE IN UK & PARTS OF EU OR ROW IF USING OUR LATCHES.]



DOOR HANDLE / LINEAR

[knurl.] **LINEAR.]**

[action.] **SPRUNG.]**

[motion.] **LEVER.]**

[details.] **SOLID METAL.]**
DIAMOND-CNC LATHE PROCESS.]

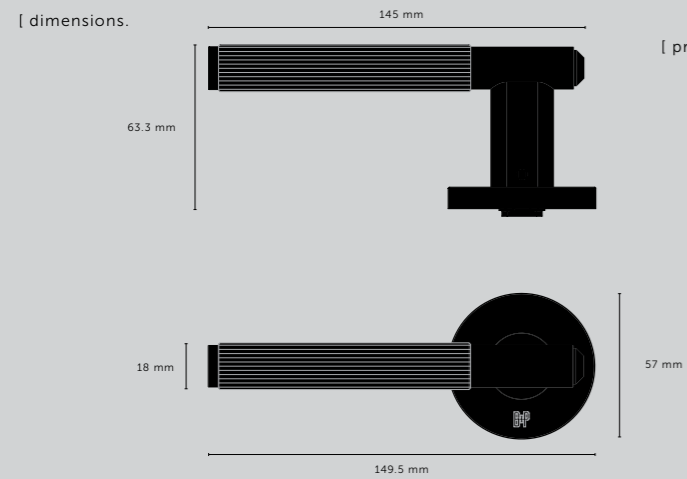

[finish.] **STEEL.]**
BRASS.]
GUN METAL*.]
WELDERS BLACK.]

[fyi.] **SOLD IN PAIRS.]**
CENTRE-DISTANCE 38 MM.]
SPRING ASSISTED ROSE TO ENSURE HANDLE RETURNS TO CENTRE.]
FITS DOORS OF THICKNESS 35 - 54MM WITH SUPPLIED FITTINGS.]
INTERIOR USE ONLY.]
FOR USE IN UK & PARTS OF EU OR ROW IF USING OUR LATCHES.]



*Gun Metal launching in Autumn 2021

FIXED DOOR HANDLE / LINEAR

[knurl.] **LINEAR.]**

[motion.] **FIXED.]**

[details.] **SOLID METAL.]**
DIAMOND-CNC LATHE PROCESS.]

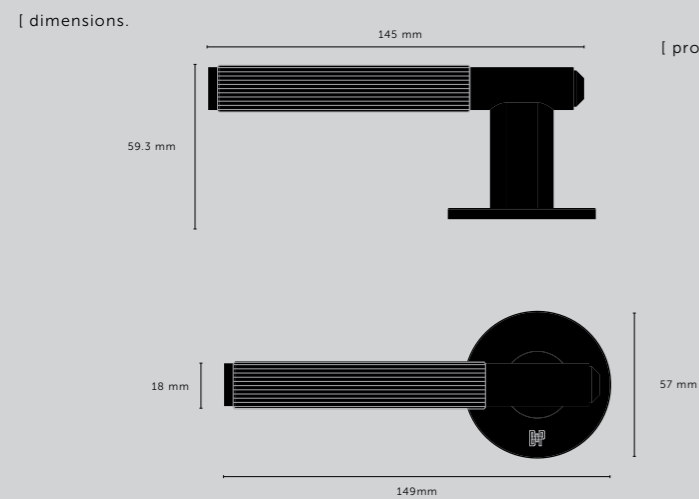

[finish.] **STEEL.]**
BRASS.]
GUN METAL*.]
WELDERS BLACK.]

[fyi.] **SOLD AS A SINGLE HANDLE.]**
HANDLE REMAINS IN FIXED POSITION.]
CAN BE FITTED TO ANY DOOR.]
INTERIOR USE ONLY.]



*Gun Metal launching in Autumn 2021



[knurl.] **LINEAR.]**
[finish.] **BRASS.]**

DOOR KNOB / LINEAR

[knurl.] **LINEAR.]**

[action.] **UNSPRUNG.]**

[motion.] **TWIST.]**

[details.] **SOLID METAL.]**
DIAMOND-CNC LATHE PROCESS.]

[dimensions.]

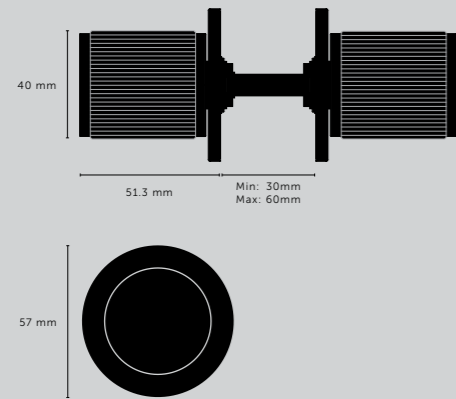

[finish.]

STEEL.]
BRASS.]
GUN METAL*.]
WELDERS BLACK.]

[fyi.]

SOLD IN PAIRS.]
PASSAGE.]
CENTRE-DISTANCE 41.5 MM (ANZ).]

[product image.]



*Gun Metal launching in Autumn 2021

FIXED DOOR KNOB / SINGLE-SIDED / LINEAR

[knurl.] **LINEAR.]**

[motion.] **FIXED.]**

[details.] **SOLID METAL.]**
DIAMOND-CNC LATHE PROCESS.]

[dimensions.]

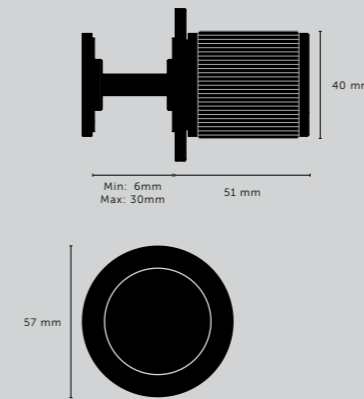

[finish.]

STEEL.]
BRASS.]
GUN METAL*.]
WELDERS BLACK.]

[fyi.]

SOLD IN SINGLES.]
DOOR KNOB REMAINS IN FIXED POSITION.]
CAN BE FITTED TO ANY DOOR.]
INTERIOR USE ONLY.]

[product image.]



*Gun Metal launching in Autumn 2021

FIXED DOOR KNOB / DOUBLE-SIDED / LINEAR

[knurl.] **LINEAR.]**

[motion.] **FIXED.]**

[details.] **SOLID METAL.]**
DIAMOND-CNC LATHE PROCESS.]

[dimensions.]

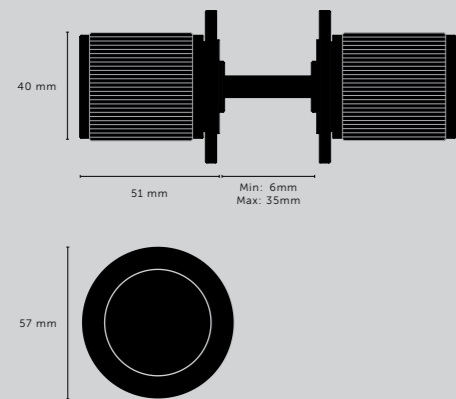

[finish.]

STEEL.]
BRASS.]
GUN METAL*.]
WELDERS BLACK.]

[fyi.]

SOLD IN PAIRS.]
DOOR KNOB REMAINS IN FIXED POSITION.]
CAN BE FITTED TO ANY DOOR.]
INTERIOR USE ONLY.]

[product image.]



*Gun Metal launching in Autumn 2021



knurl.
finish.

LINEAR.]
GUN METAL.]

THUMBTURN LOCK / CROSS

[knurl.] **CROSS.]**

[action.] **LOCK.]**

[motion.] **TWIST.]**

[details.] **SOLID METAL.]**
THIN ROSE.]
DIAMOND-CNC LATHE PROCESS.]

[dimensions.]

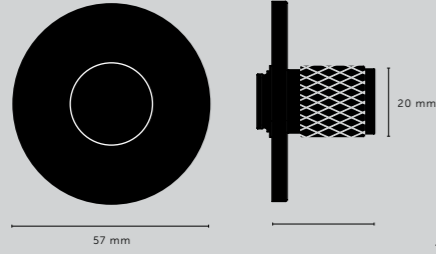

[product image.]

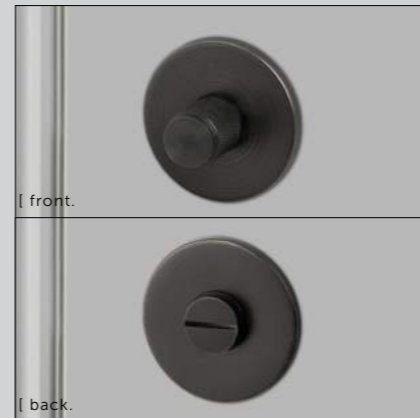

[finish.]

STEEL.]
BRASS.]
SMOKED BRONZE.] ◀
BLACK.]

[knurl.] **LINEAR.]**

[action.] **LOCK.]**

[motion.] **TWIST.]**

[details.] **SOLID METAL.]**
THIN ROSE.]
DIAMOND-CNC LATHE PROCESS.]

[dimensions.]

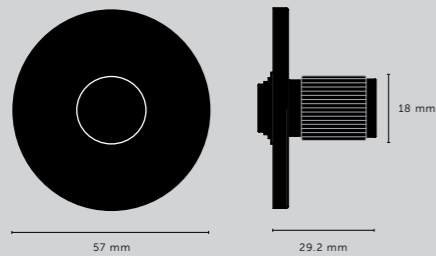

[product image.]



[finish.]

STEEL.]
BRASS.]
GUN METAL*.]
WELDERS BLACK.] ◀

[fyi.]

CENTRE-DISTANCE 41.5 MM (ANZ).]
WORKS ON ALL INTERNAL BATH ROOM & TOILET DOORS.]
INTERIOR USE ONLY.]



[knurl.]
 [finish.]

LINEAR.]
STEEL.]

KEY ESCUTCHEON

[details. **SPUN METAL.**]

[product image.]

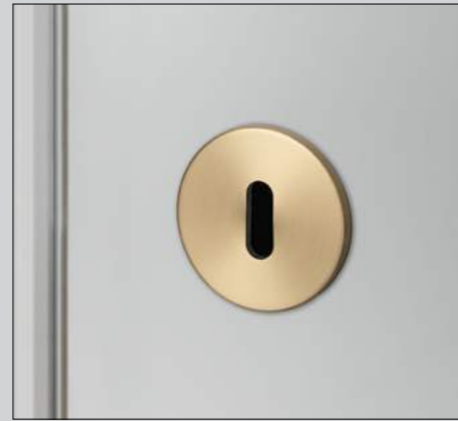

*Gun Metal & Welders Black launching in Autumn 2021

[finish.]

- STEEL.]
- BRASS.]
- SMOKED BRONZE.]
- GUN METAL*.]
- WELDERS BLACK*.]
- BLACK.]

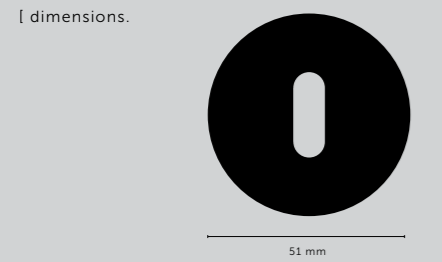

EURO CYLINDER KEY ESCUTCHEON

[details. **SPUN METAL.**]

[product image.]



*Gun Metal & Welders Black launching in Autumn 2021

[finish.]

- STEEL.]
- BRASS.]
- SMOKED BRONZE.]
- GUN METAL*.]
- WELDERS BLACK*.]
- BLACK.]

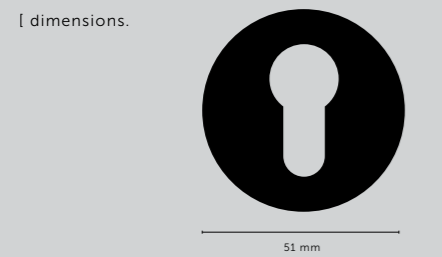

DOOR HANDLE TUBULAR LATCH

[details. **57MM BACKSET.**]
FOR USE WITH OUR DOOR HANDLES
(NOT FIXED).]

[product image.]

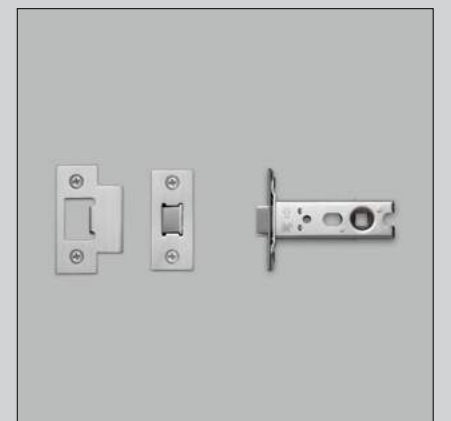

[finish.]

- STEEL.]
- BRASS.]
- BLACK.]

DOOR KNOB TUBULAR LATCH

[details. **82MM BACKSET.**]
FOR USE WITH OUR DOOR KNOBS
(NOT FIXED).]

[product image.]

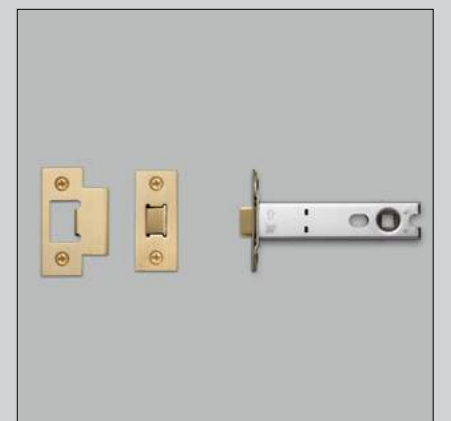

[finish.]

- STEEL.]
- BRASS.]
- BLACK.]

THUMBTURN LOCK DEADBOLT LATCH

[info. **57MM BACKSET.**]
82MM BACKSET.]
FOR USE WITH OUR THUMBTURN LOCKS.]

[product image.]

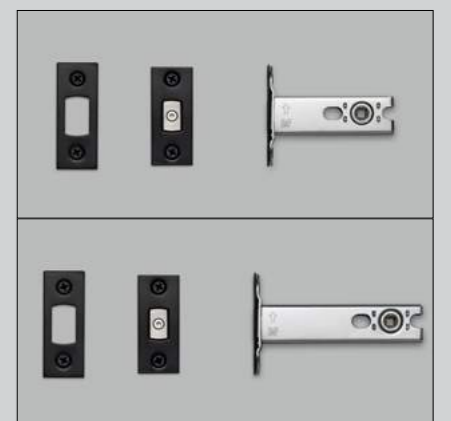

[finish.]

- STEEL.]
- BRASS.]
- BLACK.]



[location. **SHOREDITCH, GARAGE.**]

"I was working as an architect by day and building custom motorbikes by night. I taught myself how to craft solid metal into one-off custom parts. Handlebars soon turned into door handles, light switches and wall lights and Buster + Punch was born"

Massimo Buster Minale, Founder.



DOOR STOP / WALL

[knurl.] **CROSS.]**

[details.] **SOLID METAL.]
B+P EMBOSSED RUBBER STOPPER.]**

[finish.] **STEEL.]**
BRASS.] ◀
SMOKED BRONZE.]
BLACK.]

[product image.]



[dimensions.]

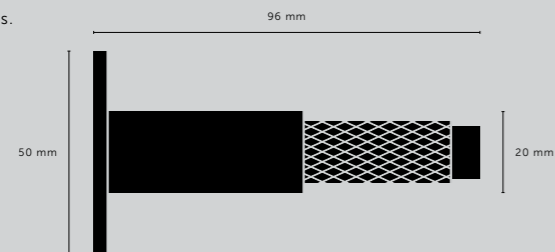

DOOR STOP / FLOOR

[knurl.] **CROSS.]**

[details.] **SOLID METAL.]
RUBBER STOPPER.]**

[finish.] **STEEL.]** ◀
BRASS.]
SMOKED BRONZE.]
BLACK.]

[product image.]



[dimensions.]

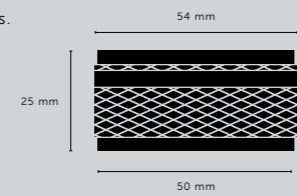

DOUBLE-SIDED PULL BAR / CROSS

[knurl.] **CROSS.]**

[details.] **SOLID METAL.]**
COIN SCREW ENDS.]

[finish.] **STEEL.]**
BRASS.]
SMOKED BRONZE.]
BLACK.]

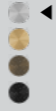

[product image.]



[scale.]

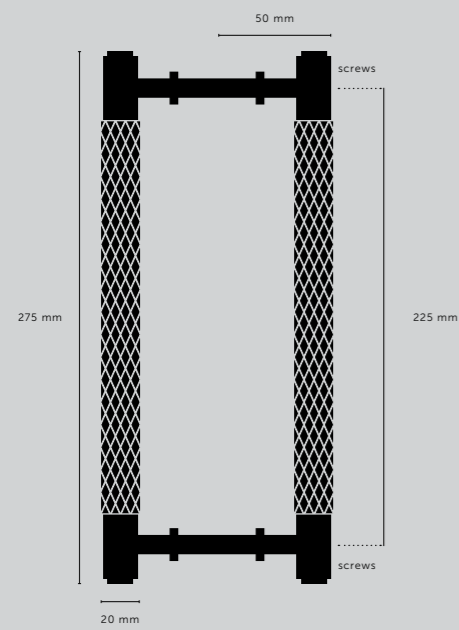

[scale.]

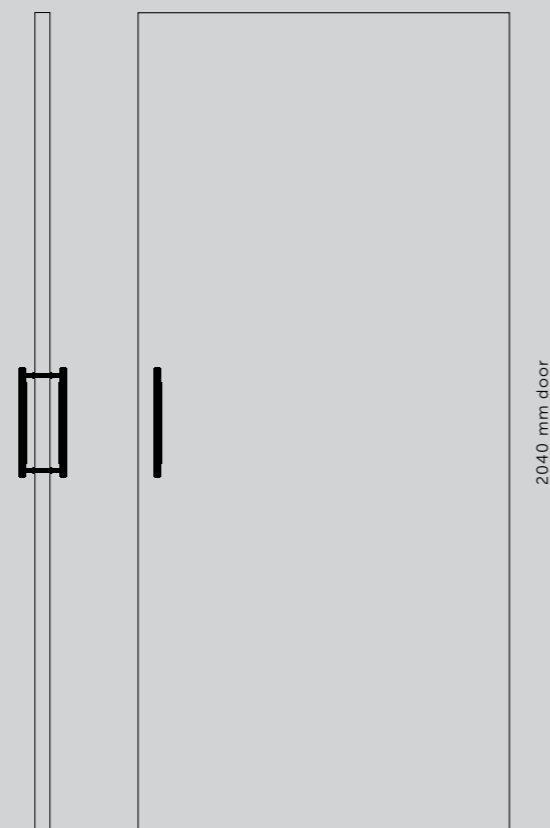

DOUBLE-SIDED CLOSET BAR / CROSS

[knurl.] **CROSS.]**

[finish.] **STEEL.]**
BRASS.]
SMOKED BRONZE.]
BLACK.]



[details.] **SOLID METAL.]**
COIN SCREW ENDS.]

[dimensions.]

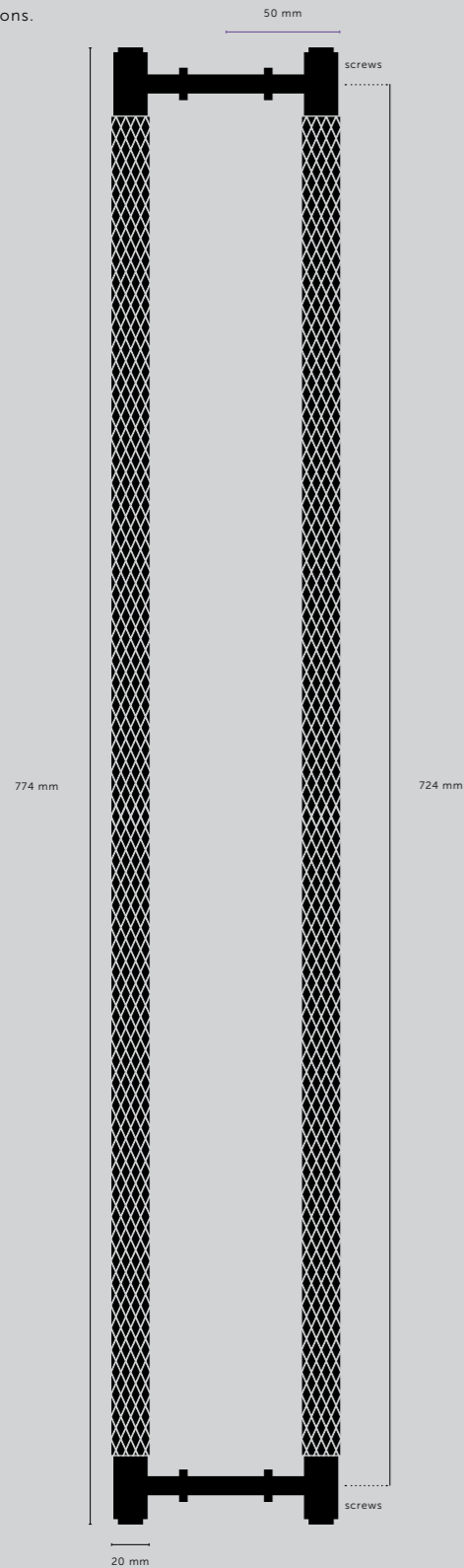

[product image.]



[scale.]

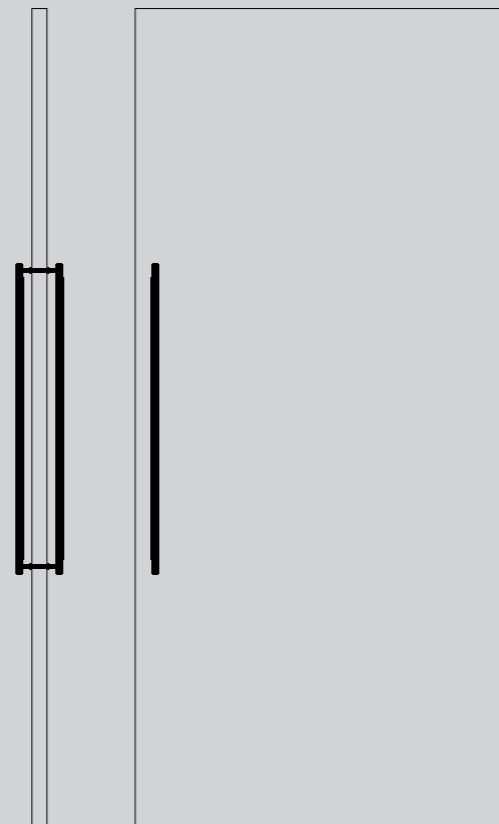

2040 mm door



[knurl.] **CROSS.]**
[finish.] **BLACK.]**



[finish. **STEEL.**]

Made from solid stainless steel and refined by hand. This is our most durable finish and will remain the same crisp finish from the moment you take it out of the box for many years to come.



[finish. **BLACK.**]

Black is made from aluminium and then anodised to give a very consistent deep black finish.



[finish. **BRASS.**]

Made from solid brass which has been precision machined and then finished with two layers of durable satin lacquer. This finish will age slowly with time, moving from a radiant brass colour to a deeper more golden finish within a few years.

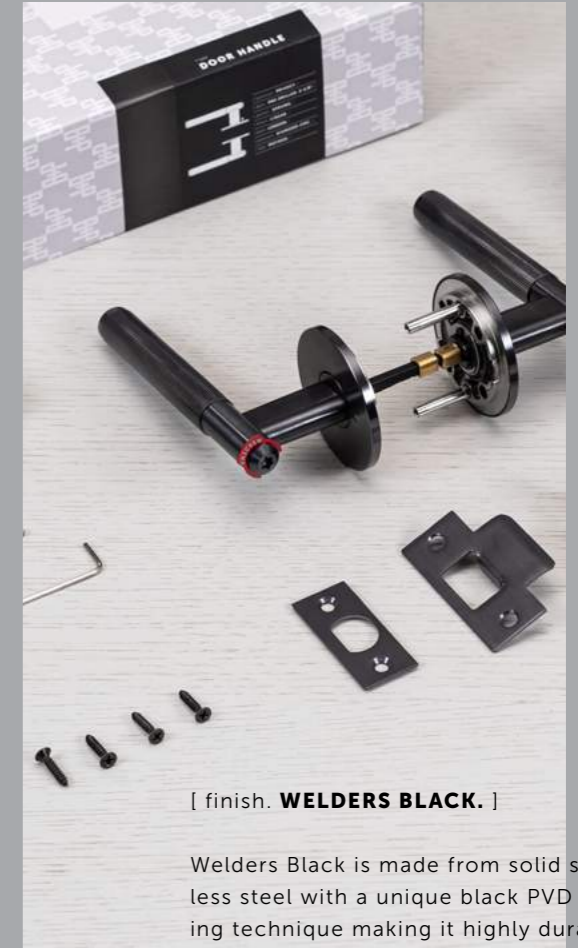

[finish. **WELDERS BLACK.**]

Welders Black is made from solid stainless steel with a unique black PVD coating technique making it highly durable. The result is a rich, deep off-black finish, reminiscent of the soft charcoals of an industrial furnace. Welders black is the epitome of beauty meets beast.



[finish. **GUN METAL.**]

Gun metal is made from solid stainless steel which is then finished in gun metal PVD. This is an extremely durable finish and will remain the same elegant finish from the moment you take it out of the box for many years to come.



[finish. **SMOKED BRONZE.**]

Made from solid brass and then hand finished with a special oxidising formula, before it is heated to give a beautiful dark bronze appearance. The finish is then hand brushed and a layer of satin lacquer applied. Smoked bronze is a 'living finish' which means it will age over time.



[finish. **BURNT STEEL®.**]

Burnt steel is made from solid stainless steel and exposed to excessive heat to create a unique and natural burnt steel finish. The heat gives the steel a rainbow of blue, purple and yellow, ensuring that no two finishes are ever the same.



[finish. **MATCHING.**]

We make all of our products from the same solid metal finishes - steel, brass, gun metal, smoked bronze, black, welders black and on special occasions, burnt steel. This makes it super easy to match all your home details from light pendants to light switches, kitchen pulls to door handles.



[entire. **HARDWARE COLLECTION.**]

The following pages feature our full range of hardware products and their product SKU's to make it easier for you to shop.

[product. **FURNITURE KNOB / CROSS.]**

[finish. **STEEL.]** [sku. **UK-KN-ST-A.]**
BRASS.] **UK-KN-BR-A.]**
SMOKED BRONZE.] **UK-KN-SM-A.]**
▶ BLACK.] **UK-KN-BL-A.]**



[page. **22.]**

[product. **FURNITURE KNOB / PLATE / CROSS.]**

[finish. **STEEL.]** [sku. **UK-KP-ST-A.]**
▶ BRASS.] **UK-KP-BR-A.]**
SMOKED BRONZE.] **UK-KP-SM-A.]**
BLACK.] **UK-KP-BL-A.]**



[page. **22.]**

[product. **FURNITURE KNOB / LINEAR.]**

[finish. **▶ STEEL.]** [sku. **GFK-07315.]**
BRASS.] **GFK-05316.]**
GUN METAL.] **GFK-35319.]**
BLACK.] **GFK-02318.]**

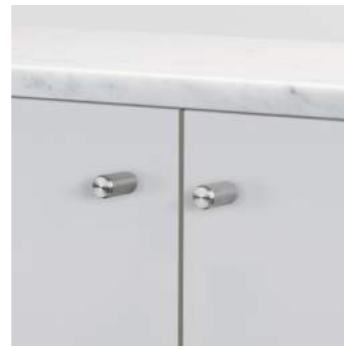

[page. **10.]**

[product. **FURNITURE KNOB / PLATE / LINEAR.]**

[finish. **STEEL.]** [sku. **GFK-07320.]**
BRASS.] **GFK-05321.]**
▶ GUN METAL.] **GFK-35324.]**
BLACK.] **GFK-02323.]**



[page. **10.]**

[product. **T-BAR / CROSS.]**

[finish. **STEEL.]** [sku. **UK-TB-H-ST-C.]**
BRASS.] **UK-TB-H-BR-C.]**
▶ SMOKED BRONZE.] **UK-TB-H-SM-C.]**
BLACK.] **UK-TB-H-BL-C.]**



[page. **30.]**

[product. **T-BAR / PLATE / CROSS.]**

[finish. **STEEL.]** [sku. **UK-TB-HP-ST-C.]**
▶ BRASS.] **UK-TB-HP-BR-C.]**
SMOKED BRONZE.] **UK-TB-HP-SM-C.]**
BLACK.] **UK-TB-HP-BL-C.]**



[page. **30.]**

[product. **L-BAR / LINEAR.]**

[finish. **BURNT STEEL®.]** [sku. **GLB-36440.]**
STEEL.] **GLB-07325.]**
BRASS.] **GLB-05326.]**
▶ GUN METAL.] **GLB-35329.]**
BLACK.] **GLB-02328.]**



[page. **16.]**

[product. **PRECIOUS BAR / LINEAR.]**

[finish. **BURNT STEEL®.]** [sku. **RCC-36441.]**
▶ BRASS.] **RCC-05421.]**



[page. **18.]**

[product. **HOOK.]**

[finish. **STEEL.]** [sku. **UK-HKH-ST-A.]**
BRASS.] **UK-HKH-BR-A.]**
▶ SMOKED BRONZE.] **UK-HKH-SM-A.]**



[page. **34.]**

[product. **DOUBLE-SIDED PULL BAR / CROSS.]**

[finish. **STEEL.]** [sku. **RPB-07277.]**
BRASS.] **RPB-05278.]**
SMOKED BRONZE.] **RPB-09279.]**
▶ BLACK.] **RPB-02280.]**



[page. **54.]**

[product. **PULL BAR / CROSS / SMALL.]**
 [finish. **STEEL.]** [sku. **UK-PB-H-160-ST-A.]**
BRASS.] **UK-PB-H-160-BR-A.]**
SMOKED BRONZE.] **UK-PB-H-160-SM-A.]**
BLACK.] **UK-PB-H-160-BL-A.]**



[page. 24.]

[product. **PULL BAR / CROSS / MEDIUM.]**
 [finish. **STEEL.]** [sku. **UK-PB-H-260-ST-A.]**
BRASS.] **UK-PB-H-260-BR-A.]**
SMOKED BRONZE.] **UK-PB-H-260-SM-A.]**
BLACK.] **UK-PB-H-260-BL-A.]**

[product. **PULL BAR / CROSS / LARGE.]**
 [finish. **STEEL.]** [sku. **UK-PB-H-360-ST-A.]**
BRASS.] **UK-PB-H-360-BR-A.]**
SMOKED BRONZE.] **UK-PB-H-360-SM-A.]**
BLACK.] **UK-PB-H-360-BL-A.]**

[product. **PULL BAR / PLATE / CROSS / SMALL.]**
 [finish. **STEEL.]** [sku. **UK-PB-HP-160-ST-A.]**
BRASS.] **UK-PB-HP-160-BR-A.]**
SMOKED BRONZE.] **UK-PB-HP-160-SM-A.]**
BLACK.] **UK-PB-HP-160-BL-A.]**



[page. 26.]

[product. **PULL BAR / PLATE / CROSS / MEDIUM.]**
 [finish. **STEEL.]** [sku. **UK-PB-HP-260-ST-A.]**
BRASS.] **UK-PB-HP-260-BR-A.]**
SMOKED BRONZE.] **UK-PB-HP-260-SM-A.]**
BLACK.] **UK-PB-HP-260-BL-A.]**

[product. **PULL BAR / PLATE / CROSS / LARGE.]**
 [finish. **STEEL.]** [sku. **UK-PB-HP-360-ST-A.]**
BRASS.] **UK-PB-HP-360-BR-A.]**
SMOKED BRONZE.] **UK-PB-HP-360-SM-A.]**
BLACK.] **UK-PB-HP-360-BL-A.]**

[product. **PULL BAR / LINEAR / SMALL.]**
 [finish. **STEEL.]** [sku. **GPB-07285.]**
BRASS.] **GPB-05286.]**
GUN METAL.] **GPB-35289.]**
BLACK.] **GPB-02288.]**



[page. 12.]

[product. **PULL BAR / LINEAR / MEDIUM.]**
 [finish. **STEEL.]** [sku. **GPB-07290.]**
BRASS.] **GPB-05291.]**
GUN METAL.] **GPB-35294.]**
BLACK.] **GPB-02293.]**

[product. **PULL BAR / LINEAR / LARGE.]**
 [finish. **STEEL.]** [sku. **GPB-07295.]**
BRASS.] **GPB-05296.]**
GUN METAL.] **GPB-35299.]**
BLACK.] **GPB-02298.]**

[product. **PULL BAR / PLATE / LINEAR / SMALL.]**
 [finish. **STEEL.]** [sku. **GPB-07300.]**
BRASS.] **GPB-05301.]**
GUN METAL.] **GPB-35304.]**
BLACK.] **GPB-02303.]**



[page. 14.]

[product. **PULL BAR / PLATE / LINEAR / MEDIUM.]**
 [finish. **STEEL.]** [sku. **GPB-07305.]**
BRASS.] **GPB-05306.]**
GUN METAL.] **GPB-35309.]**
BLACK.] **GPB-02308.]**

[product. **PULL BAR / PLATE / LINEAR / LARGE.]**
 [finish. **STEEL.]** [sku. **GPB-07310.]**
BRASS.] **GPB-05311.]**
GUN METAL.] **GPB-35314.]**
BLACK.] **GPB-02313.]**

[product. **CLOSET BAR / CROSS.]**
 [finish. **STEEL.]** [sku. **UK-CB-760-ST-A.]**
BRASS.] **UK-CB-760-BR-A.]**
SMOKED BRONZE.] **UK-CB-760-SM-A.]**
BLACK.] **UK-CB-760-BL-A.]**



[page. 28.]

[product. **DOUBLE-SIDED CLOSET BAR / CROSS.]**
 [finish. **STEEL.]** [sku. **RCB-07281.]**
BRASS.] **RCB-05282.]**
GUN METAL.] **RCB-09283.]**
BLACK.] **RCB-02284.]**



[page. 56.]

[product. **DOOR KNOB / LINEAR.]**
 [finish. **STEEL.]** [sku. **RDK-071054.]**
BRASS.] **RDK-051053.]**
GUN METAL.] **RDK-091055.]**
WELDERS BLACK.] **RDK-481052.]**



[page. 44.]

[product. **FIXED DOOR KNOB / DOUBLE-SIDED / CROSS.]**
 [finish. **STEEL.]** [sku. **RDK-071062.]**
BRASS.] **RDK-051061.]**
GUN METAL.] **RDK-091063.]**
WELDERS BLACK.] **RDK-481060.]**

[product. **FIXED DOOR KNOB / SINGLE-SIDED / CROSS.]**
 [finish. **STEEL.]** [sku. **RDK-071058.]**
BRASS.] **RDK-051057.]**
GUN METAL.] **RDK-091059.]**
WELDERS BLACK.] **RDK-481056.]**

[product. **DOOR KNOB / CROSS.]**
 [finish. **STEEL.]** [sku. **GDK-07254.]**
BRASS.] **GDK-05255.]**
▶ BLACK.] **GDK-02257.]**



[page. 40.]

[product. **DOOR HANDLE / CROSS / SPRUNG / CC 38 MM.]**
 [finish. **STEEL.]** [sku. **UK-LH-S-38-ST-A.]**
▶ BRASS.] **UK-LH-S-38-BR-A.]**
SMOKED BRONZE.] **UK-LH-S-38-SM-A.]**
BLACK.] **UK-LH-S-38-BL-A.]**



[page. 38.]

[product. **DOOR HANDLE / CROSS / UNSPRUNG / CC 30 MM / SWEDEN.]**
 [finish. **STEEL.]** [sku. **SW-LH-U-30-ST-A.]**
BRASS.] **SW-LH-U-30-BR-A.]**
SMOKED BRONZE.] **SW-LH-U-30-SM-A.]**
BLACK.] **SW-LH-U-30-BL-A.]**



[product. **DOOR HANDLE / CROSS / UNSPRUNG / CC 38 MM.]**
 [finish. **STEEL.]** [sku. **UK-LH-U-38-ST-A.]**
BRASS.] **UK-LH-U-38-BR-A.]**
SMOKED BRONZE.] **UK-LH-U-38-SM-A.]**
BLACK.] **UK-LH-U-38-BL-A.]**



[page. 38.]

[product. **FIXED DOOR HANDLE / CROSS.]**
 [finish. **STEEL.]** [sku. **RLH-07226.]**
BRASS.] **RLH-05227.]**
▶ SMOKED BRONZE.] **RLH-09228.]**
BLACK.] **RLH-02229.]**



[product. **DOOR HANDLE / LINEAR.]**
 [finish. **STEEL.]** [sku. **RLH-051033.]**
BRASS.] **RLH-071034.]**
▶ GUN METAL.] **RLH-091035.]**
WELDERS BLACK.] **RLH-481032.]**



[page. 42.]

[product. **FIXED DOOR HANDLE / LINEAR.]**
 [finish. **STEEL.]** [sku. **RLH-051045.]**
BRASS.] **RLH-071046.]**
SMOKED BRONZE.] **RLH-091047.]**
BLACK.] **RLH-481044.]**



[product. **DOOR STOP / FLOOR.]**
 [finish. **STEEL.]** [sku. **RDS-07269.]**
▶ BRASS.] **RDS-05270.]**
SMOKED BRONZE.] **RDS-09271.]**
BLACK.] **RDS-02272.]**



[page. 52.]

[product. **DOOR STOP / WALL.]**
 [finish. **STEEL.]** [sku. **RDS-07265.]**
BRASS.] **RDS-05266.]**
SMOKED BRONZE.] **RDS-09267.]**
▶ BLACK.] **RDS-02268.]**



[product. **KEY ESCUTCHEON PLATE / CC 27 MM / SWEDEN.]**
 [finish. **STEEL.]** [sku. **SW-ESC-27-ST-A.]**
BRASS.] **SW-ESC-27-BR-A.]**
▶ SMOKED BRONZE.] **SW-ESC-27-SM-A.]**
BLACK.] **SW-ESC-27-BL-A.]**



[page. 48.]

[product. **KEY ESCUTCHEON PLATE / CC 35 MM.]**
 [finish. **STEEL.]** [sku. **UK-ESC-35-ST-A.]**
BRASS.] **UK-ESC-35-BR-A.]**
SMOKED BRONZE.] **UK-ESC-35-SM-A.]**
BLACK.] **UK-ESC-35-BL-A.]**



[product. **EURO CYLINDER PLATE / CC 27 MM / SWEDEN.]**
 [finish. **▶ STEEL.]** [sku. **SW-CYL-27-ST-A.]**
BRASS.] **SW-CYL-27-BR-A.]**
SMOKED BRONZE.] **SW-CYL-27-SM-A.]**
BLACK.] **SW-CYL-27-BL-A.]**



[page. 48.]

[product. **EURO CYLINDER PLATE / CC 35 MM.]**
 [finish. **STEEL.]** [sku. **UK-CYL-35-ST-A.]**
BRASS.] **UK-CYL-35-BR-A.]**
SMOKED BRONZE.] **UK-CYL-35-SM-A.]**
BLACK.] **UK-CYL-35-BL-A.]**



[product. **THUMBTURN LOCK / CC 27 MM / SWEDEN.]**
 [finish. **STEEL.]** [sku. **SW-TT-27-ST-A.]**
BRASS.] **SW-TT-27-BR-A.]**
SMOKED BRONZE.] **SW-TT-27-SM-A.]**
BLACK.] **SW-TT-27-BL-A.]**



[page. 46.]

[product. **THUMBTURN LOCK / CC 38 MM.]**
 [finish. **STEEL.]** [sku. **UK-TT-38-ST-A.]**
▶ BRASS.] **UK-TT-38-BR-A.]**
SMOKED BRONZE.] **UK-TT-38-SM-A.]**
BLACK.] **UK-TT-38-BL-A.]**



[product. **TUBULAR LATCH / FOR DOOR HANDLE / 57MM BACKSET**
 [finish. **STEEL.]** [sku. **GLL-071161.]**
BRASS.] **GLL-051160.]**
BLACK.] **GLL-021163.]**



[page. 49.]

[product. **TUBULAR LATCH / FOR DOOR KNOB / 82MM BACKSET**
 [finish. **STEEL.]** [sku. **GLL-051166.]**
BRASS.] **GLL-071167.]**
BLACK.] **GLL-021169.]**



[product. **DEADBOLT LATCH / FOR THUMBTURN LOCK / 57MM BACKSET**
 [finish. **STEEL.]** [sku. **GLL-051172.]**
BRASS.] **GLL-071173.]**
BLACK.] **GLL-021175.]**



[page. 49.]

[product. **DEADBOLT LATCH / FOR THUMBTURN LOCK / 82MM BACKSET**
 [finish. **STEEL.]** [sku. **GLL-051178.]**
BRASS.] **GLL-071179.]**
BLACK.] **GLL-021181.]**



[our. **WORLD.**]

We are the same today as we have always been. A young, independent, free-thinking brand from London that is passionate about the crafted products we make, the city we live in and the sub-cultures that inspire us". To get a glimpse into our world visit: **BUSTERANDPUNCH.COM**





[our. **DESIGNER.**]

Products and content designed by renowned London architect, Massimo Buster Minale, including collaborations with fashion designers, rockstars, street artists and the notorious.

BUSTER + PUNCH / UK

29 St. Peters Street
Stamford, PE9 2PF
United Kingdom
+44 (0)20 7407 0888

BUSTER + PUNCH / STOCKHOLM

Artillerigatan 25
114 45 Stockholm
Sweden
+46 (0)8 588 395 50

BUSTER + PUNCH / NORTH AMERICA

10844 Burbank Blvd.
North Hollywood, ca 91601
United States
+1 (818) 392-3827

PRESS ENQUIRIES

Global Press: press@busterandpunch.com
North American Press: press@busterandpunch.us

SALES ENQUIRIES

Global Sales: sales@busterandpunch.com
North American Sales: sales@busterandpunch.us

INFORMATION

info@busterandpunch.com

FOLLOW US

Instagram: [@busterandpunch](https://www.instagram.com/busterandpunch)
Facebook: [busterandpunch](https://www.facebook.com/busterandpunch)

[end. **ORDINARY.**]

